

CHAPTER 2. ADJUSTMENTS

[1] Adjustments

General

Since the following adjustments and settings are provided for this model, make adjustments and/or setup as necessary.

1. Adjustments

Adjustments of output voltage (FACTORY ONLY)

1. Install the power supply unit in the machine.
2. Set the recording paper and document.
3. When the document is loaded, power is supplied to the output lines.
Confirm that outputs are within the limits below.

Output voltage settings

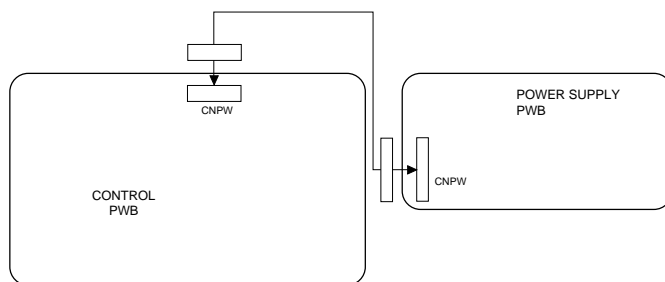

Fig. 1

Output	Voltage limits	Connector No.	CNPW
+5V	4.75V~5.25V	1	VM
+12V	11.5V~12.5V	2	VM
VM (+24V)	23.04V~24.96V	3	VM
		4	MG
		5	MG
		6	MG
		7	+5V
		8	+5V
		9	DG
		10	DG
		11	+12V
		12	AG

2. IC protectors replacement

ICPs (IC Protectors) are installed to protect the TX motor drive circuit and verification stamp drive circuit. ICPs protect various ICs and electronic circuits from an overcurrent condition.

The location of ICPs are shown below:

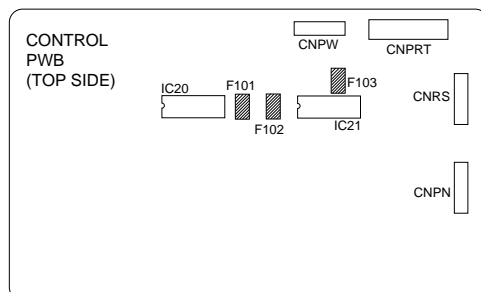

Fig. 2

- (1) F102 (CCP2E20) is installed in order to protect IC's from and overcurrent generated in the verification stamp drive circuit. If F102 is open, replace it with a new one.
- (2) F101, F103 (CCP2E30) is installed in order to protect IC's from an overcurrent generated in the TX motor drive circuit. If F101, F103 is open, replace it with a new one.

In addition to the replacement of F101, F103 and F102, the factor causing F101, F103 and F102 to open must also be repaired. If not, F101, F103 and F102 will open again.

Replacement parts

CCP2E20 (Sharp code: VHVCCP2E20/-1)

CCP2E30 (Sharp code: VHVCCP2E30/-1)

3. Volume adjustment

You can adjust the volume of the speaker, handset, and ringer using the **UP** and **DOWN** keys on the operation panel (flip up the Rapid Key overlay to access the keys).

Speaker

The speaker has 3 volume levels: HIGH, MIDDLE, and LOW. To adjust the volume of the speaker, press the **SPEAKER** key and then press the **UP** or **DOWN** key until the desired level appears in the display. Press the **SPEAKER** key again to turn the speaker off.

Handset

The handset receiver has 3 volume levels: HIGH, MIDDLE, and LOW. To adjust the volume of the handset receiver, lift the handset and then press the **UP** or **DOWN** key until the desired level appears in the display.

Ringer

The ringer has 4 volume levels: HIGH, MIDDLE, LOW, and OFF. To adjust the volume of the ringer, press the **UP** or **DOWN** key until the desired level appears in the display (make sure the **SPEAKER** has not been pressed and the handset is not lifted). The fax will ring at the new volume level each time you change the level. If you select OFF, press the **START** key to confirm your selection.

4. Settings

(1) Dial mode selector

OPTION SETTING: DIAL MODE (Soft Switch No. SW2 DATA No. 1)
Use this to set the fax machine to the type of telephone line you are on.

- The factory setting is "TONE".

OPTIONAL SETTING: DIAL MODE

Soft Switch No. SW2 DATA No.1 for Line 1
No. SW15 DATA No.1 for Line 2

Use this to set the fax machine to the type of telephone line you are on.

- The factory setting is "TONE".

(step 1) Select "OPTION SETTING".

KEY: **FUNCTION** (4)

DISPLAY: 4:OPTION SETTING ↔ ENTER #01→33,×,#

(step 2) Select "DIAL MODE".

KEY: (2) (3)

DISPLAY: 23:DIAL MODE ↔ 1=LINE 1,2=LINE 2

(step 3) Select "LINE", using "1" or "2".

KEY: (1)

DISPLAY: 1:LINE 1 ↔ 1=TONE, 2=PULSE

KEY: (2)

DISPLAY: 2:LINE 2 ↔ 1=TONE, 2=PULSE

(step 4) Select, using "1" or "2".

KEY: (1)

DISPLAY: TONE SELECTED

KEY: (2)

DISPLAY: PULSE SELECTED

(step 5) End, using the "STOP" key.

KEY: **STOP**

[2] Diagnostics and service soft switch

1. Operating procedure

Two kinds of diagnoses are supported.

1-1. Fax diagnosis

This diagnosis is concerned with the main body of fax which is used for production and service support.

Entering the diagnostic mode

Press **FUNC** → **9** → ***** → **8** → **#** → **7**, and the following display will appear.

```
MAIN: FBQ0* FBQ1*
SUB:  FBR0* FBR0*
```

Then press the **START** key. Select the desired item with the ***** key and the **#** key or select with the rapid key.

Enter the mode with the **START** key.

(Diag •specifications)

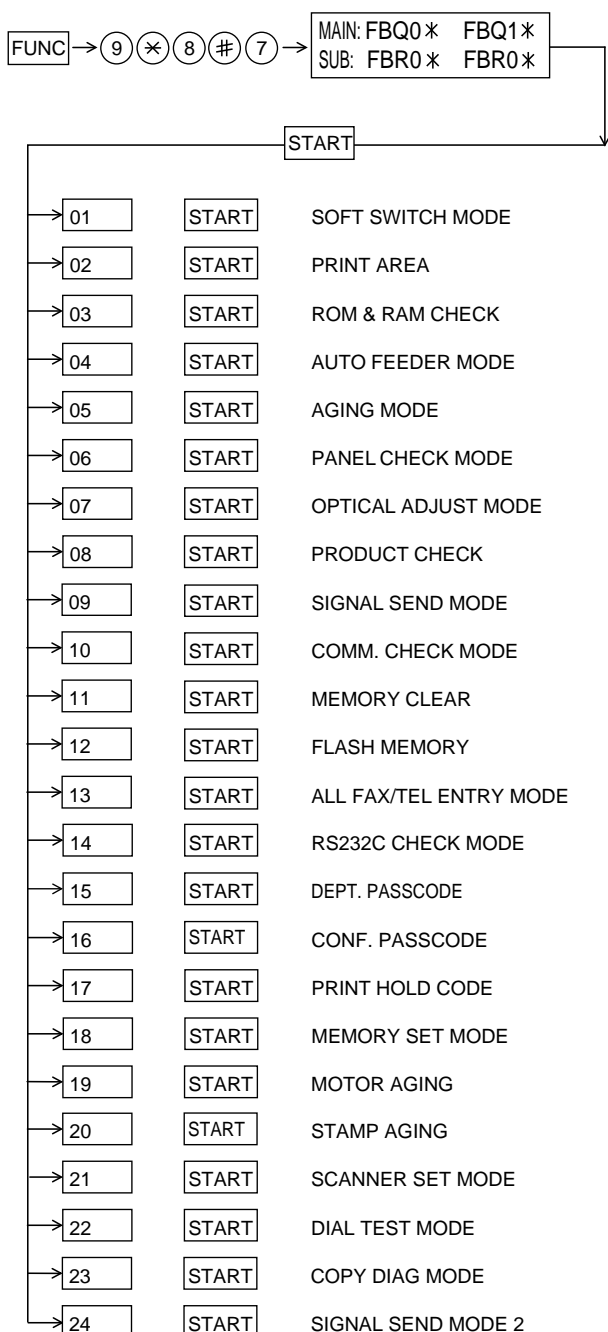

1-2. Print diagnosis

This diagnosis is concerned with the print which is used for production and service support.

Entering the diagnostic mode

Press **FUNC** → **9** → ***** → **8** → **#** → **6**, and the following display will appear.

```
PCU ROM Ver.: **
```

Then press the **START** key. Select the desired item with the ***** key and the **#** key or select with the rapid key.

Enter the mode with the **START** key.

(Diag •specifications)

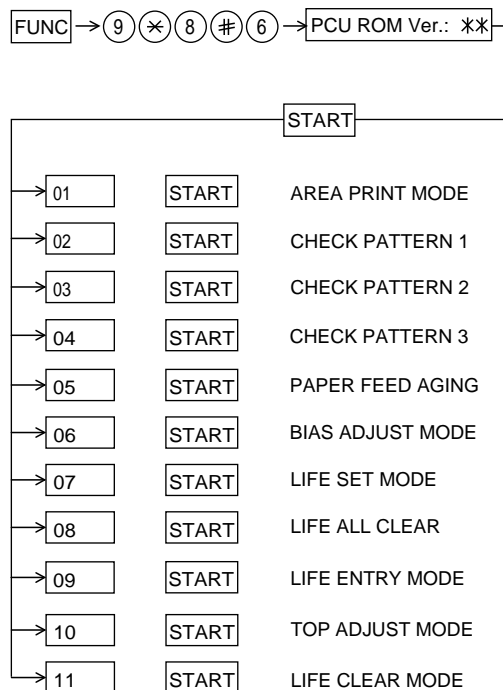

3) Memory clear when power is turned on

Pressing the **START** and **STOP** keys, turn on the main power, and the following message will be displayed.

```
MEMORY CLEAR
EXECUTE ? 1 = YES , 2 = NO
```

Here, when 1: YES is selected, the memory will be cleared to be ready for operation.

If 2: NO is selected, it will continue ready for operation as it is.

2. Diagnostic items description

2-1. Fax diagnosis

1) Soft switch mode

In this mode, the soft switch are set and the soft switch list is printed.
Soft switch mode screen

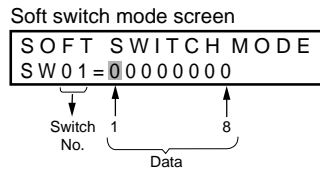

① Switch number selection

- Press START key for setting of the next soft switch. If the soft switch number is the final, pressing START key will exit the soft switch mode.
- Enter two digits of a soft switch number to set the switch number. If a switch number of unexisting soft switch is entered, key error buzzer sounds to reject the input.



② Data number selection

The cursor position shows the data to be set.

Pressing # key moves the cursor to the right. If, however, the cursor is on data number 8, pressing # key shifts the cursor to data number 1 of the next switch number. If the switch number is the final, pressing # key will exit the soft switch mode.

Pressing ✕ key moves the cursor to the left. If, however, the cursor is on data number 1, pressing ✕ key shifts the cursor to data number 1 of the former switch number. If the switch number is 1, pressing key will not move the cursor.

③ Data setting method

Press the FUNCTION key, and the data at the position of the cursor will be reversed to 0 when it is 1, or to 1 when it is 0. (If the soft switch can be changed at the bit (Refer to ⑥.), the error buzzer will sound with the process not received.)

④ Outputting method of soft switch list

In the soft switch mode, press the REPORT key, and the soft switch list will be output.

If the recording paper runs out or is clogged, the key error buzzer will sound with the process not received.

⑤ Storage of data

In the following case, the data of the soft switches set will be stored.

- It is shifted to set the next soft switch by pressing the START switch.
- It is shifted to set the next soft switch with the [#] key.
- It is shifted to set the last soft switch with the [✕] key.
- It is shifted to set another soft switch by inputting two digits as the switch number. (When 2 digits are completely input.)
- Output of the soft switch list is started.

⑥ Inhibition of data change

(This is also applicable for the optional setting.)

In the following case, it is inhibited to change the data with the key error buzzer.

- When the print hold bus code is not registered, the print hold function is turned from OFF to ON.
- When the print hold function is on, the print hold bus code is cleared.
- When the memory is used because of substitutive receiving, etc, the print hold function is mutually turned on/off.
- OFF to ON of telephone billing function which is using the image memory is used (Note: In the existing set, the telephone billing code function is specified from OFF to ON when the timer system communication (including the batch communication) is set.) Here, the memory is usable when the telephone billing code function is on. It can be set from ON to OFF while the memory is used. However, if setting is practically changed even once, it can not be returned from OFF to ON.

- Mutual switch of ON/OFF of PC interface function during operation of image memory.
 - When the PC interface board is not mounted, [Switch of OFF → ON of the item of "PC interface function" and of FAX → PC of the item of "automatic receiving in the PC interface mode] (Note: This supports not only the operation protect of the optional setting and soft switch mode but also an example of the automatic compensation of soft switch to OFF/FAX when the power is turned on even if the PC PWB is removed when the optional setting and soft switch mode are set at ON/PC.) (Though they are not provided, the existing model can operate without setting of the soft switch when it is not installed.)
 - OFF to ON of multi TTI function and telephone billing code function when the department control function is OFF.
 - OFF to ON of department control function during use of image memory. (Note: In the existing set, the department control function is set from OFF to ON when the timer communication (including the batch sending) or the memory hold is set.)
 - ON to OFF of continuous serial polling function when the continuous serial polling is started. (Note: In the existing set, "ON to OFF of the continuous serial polling function when the continuous serial polling is registered" has been applied, but the conditions are now moderated. However, registration is impossible to the program of the new continuous serial polling when the continuous serial polling function is OFF.)
 - In addition, change of all soft switches during communication
- ⑦ Linked change of data (This is the same even in the optional setting.)
- When the department control function is off, the multi TTI function and telephone billing code function are turned off.

2) Print area

According to the size of the specified sheet, the effective printing area is printed.

3) ROM & RAM check

The sum value of ROM, the work and the back-up RAM are checked. The RS232C interface is also checked. If any error occurs, the buzzer will inform it. (Refer to the following table). Finally, the result will be printed. This diagnosis does not check the flash memory. The flash memory is checked with the flash memory test.

Number of buzzer sounds	Device checked	Remarks
1 time <Short sound>	ROM1	Main
2 times <Short sounds>	ROM2	Main
3 times <Short sounds>	Integrated ROM/RAM	Main
4 times <Short sounds>	D-RAM	Main
5 times <Short sounds>	S-RAM	Main
*6 times <Short sounds>	S-RAM (on the optional memory)	Main
1 time <Long sound>	ROM	Sub 1
2 times <Long sounds>	Integrated ROM/RAM	Sub 1
3 times <Long sounds>	D-RAM	Sub 1
4 times <Long sounds>	ROM	Sub 2
5 times <Long sounds>	Integrated ROM/RAM	Sub 2
6 times <Long sounds>	D-RAM	Sub 2

* As practical, it is judged that the optional memory is not installed if any error occurs. Therefore, it does sometimes not sound.

For the short and long sounds, one pattern is as follows.

Main system: 0.25 seconds ON/0.25 seconds OFF

Sub system: 1.00 second ON/0.25 seconds OFF

The execution state of checking is as follows. Moreover, the list of the check result is output after checking is ended.

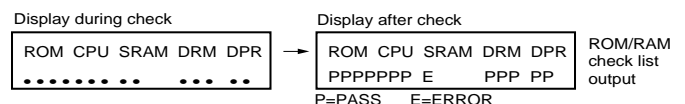

<Relationship between display and memory>

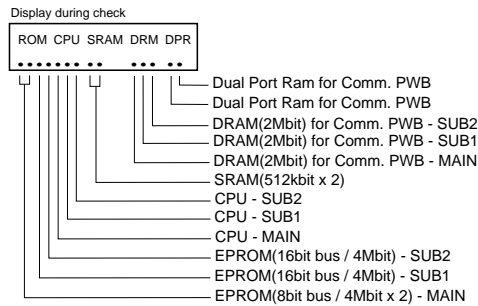

The check result of RS232C interface board is listed and printed together with the check result of ROM&RAM.

4) Auto feeder mode

The auto feed function can be checked by inserting and discharging the document. (The distance between pages can be displayed during operation of the scanner.)

① Check of auto feed function

After this mode is activated, set up the document, and press the START key, and it will be automatically fed. (Before the START key is pressed, the document sensor alone is activated.) Moreover, the document size (A4/B4) and sensor information (A4/B4/ORG) are displayed when the document sensor is turned.

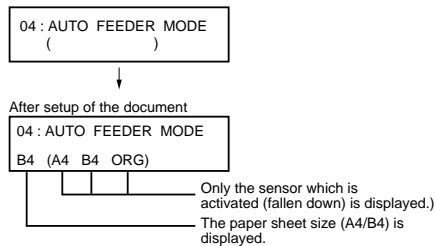

② Display of distance between pages during operation of the scanner

- Soon after this mode is activated, press the FUNCTION key for 5 seconds or more, and the display mode of the distance between pages will be activated. Then, set up the sending paper and select the image quality, and then press the START key, and operation will be started.
Be sure to press the FUNCTION key prior to the START key. If the FUNCTION key is not pressed but the START key is pressed, it will operate in the same manner as in the existing auto feeder mode.
If the START key is pressed, the FUNCTION key will be invalid hereafter. Therefore, the display mode of the distance between pages and the existing mode can not be changed.
- While the sending paper is read, the image quality key can be input. STD/FINE/S-FINE modes are usable. However, the same operation of FINE will be selected if the intermediate tone is set.
- The image quality, the length of the sending page read, the page distance to the next sending paper and the total of the sending papers read are shown on the display.
- When the stop key is pressed or 100 sending papers are read, the content shown on the display will be totally output as the list after the remaining sending papers are discharged.

5) Aging mode

If any document is set up in the first state (when started), copying will be executed. If it is not set up, "check pattern 1" of the print diagnosis is output at the intervals of 1 time/60 minutes. (A total of 10 sheets are output.)

6) Panel check mode

This is used to check whether each key is normally operated or not. According to the key input, LCD is displayed. Moreover, during execution, the document reading lamp is turned on.

- ① When [PANEL CHECK MODE] is displayed, press the [START] key. The test will be started. When the test is started, LED's will sequentially come on. It is used to check all LED's.
- ② Press any other key except [STOP] key.
At this time, the name of each key will be displayed every push of the key.
- ③ However, if any key is pressed with the page plate opened, it will be equal to a press of key 32 with the page plate opened.
- ④ Finally press the [STOP] key.
If all keys can be input, the key input "ALL KEY OK!!" will be displayed when the STOP key is ended.
The screen will be all displayed in black, and the test result will be printed.

In this test, it is okay if all the other keys except [STOP] key have been pressed from start of the test to its end (the [STOP] key is pressed). If any key is skipped, it will be regarded as "KEY ERROR!!", and the name of the key not pressed will be printed on the list as the result. This will complete printing.

- If the ten-key pad is used to input in this mode, DTMF corresponding to the pressed key is sent out continuously (lines 1/2 simultaneously).

7) Optical adjust mode

The document reading LED is turned on.

8) Product check

The diagnosis is used in the production process. After shift to the mode, the following operations are sequentially executed. At this time, the sensor of read-error can be checked by feed-ing the B3 document. Set up one short document of B4 size.

- ① Memory clear (Same as Diagnosis 11)
- ② Panel test (Same as Diagnosis 06)
- ③ Dial test (Same as Diagnosis 24)
- ④ Document feed
- ⑤ Stamp press
- ⑥ ROM & RAM test, RS232C interface board check (Same as the Diagnosis 03)
- ⑦ Flash memory test mode (Same as Diagnosis 12)
- ⑧ Registration of fixed data
Registration of rapid key No. and other data necessary for production.
The registered data are shown in the following table. The chain dial is not set for any destination.

Rapid No.	FAX No.	Rapid No.	FAX No.	Rapid No.	FAX No.	Rapid No.	FAX No.
01	20	06	25	11	1	21	01
02	21	07	26	12	2	22	02
03	22	08	27	13	3	23	03
04	23	09	28	14	4	24	04
05	24	10	29	15	5	25	05

- ⑨ Transmission check (Same as Diagnosis 10)
The soft switches necessary for production are set.
- ⑩ Test result print (two sheets)
 - AUTO FEEDER CHECK LIST
 - FLASH MEMORY CHECK LIST
Memory clear printing
Panel test result printing
ROM&RAM test result printing
Check result printing of RS232C interface board
- ⑪ Print area printing (one sheet)

9) Signal send mode

After shift to the mode, press the START key, and the signals will be transmitted in the following sequence.

It can be used to check the modem and so on.

- The selection signal is sent out simultaneously from the lines 1/2 in this mode.
 - [1] No signals
 - [2] 4800BPS (V27ter)
 - [3] 14400BPS (V. 33)
 - [4] 12000BPS (V. 33)
 - [5] 14400BPS (V. 17)
 - [6] 12000BPS (V. 17)
 - [7] 9600BPS (V. 17)
 - [8] 7200BPS (V. 17)
 - [9] 9600BPS (V. 29)
 - [10] 7200BPS (V. 29)
 - [11] 4800BPS (V27ter)
 - [12] 2400BPS (V27ter)
 - [13] 300BPS (FLAG)
 - [14] 2100Hz (CED)
 - [15] 1100Hz (CNG)

10) Comm. check mode

- ① Turn on the line monitor.
 - ② Turn off the cover sheet function.
 - ③ Set 0 km at the line equivalence.
 - ④ Bring the copy mode into the continuity mode.
 - ⑤ It is set to shift into the diagnosis mode when the SPEED key alone is pressed.
- After the check, it is necessary to be sure to return the aforementioned soft switches into the initial state.
(Clear the memory with the diagnosis.)

11) Memory clear

Clear the back-up memory to initialize the soft switches.
The flash memory will be initialized. Then, the initialized list be output.

12) Flash memory

The flash memory is checked.
The ordinary memories (ROM, SRAM, DRAM) are checked in the ROM&RAM check process. The write/read test is taken every block to print the result.

When an error occurs, the following error buzzer will sound.

Number of buzzer sounds	Check device
7 times <Short sounds>	Page memory
8 times <Short sounds>	Flash memory
9 times <Short sounds>	Flash memory (optional)

During operation of this diagnosis, dual operation is not possible at all.
If this is excessively repeated, it will shorten the life of the flash memory.

13) All FAX/TEL. entry mode

The function is used to simplify the registration of FAX/TEL No. during aging.

First, write the reference destination No. with the Rapid No. 01 key in the FAX No. registration mode before start of the diagnosis.

- ① The diagnosis mode is activated. If anything is not registered in the Rapid No. 01 or any program or group is not registered, it will pass the diagnosis without doing anything.
- ② The FAX/TEL No. (including the substitutive destination) of the Rapid No. 01 is copied to the Rapid Nos. 02 thru 48.
- ③ FAX No. of the Rapid No. 01 is copied to SPEED key Nos. 001 thru 200.
- ④ If any chain dial is not in the Rapid No., the Rapid Nos. 02 thru 48 and SPEED key Nos. 001 thru 200 are registered in the group No. 01. If any chain dial is not set, the group will be not produced but the chain dial setting alone of the Rapid No. 01 will be reset. (In all others except the Rapid No. 01, the chain dials will be continuously set as they are.)

(16th and subsequential letters of the destination name registered in the Rapid No. 01 will be discarded.)

14) RS232C check mode

RS232C interface board is checked.

When the interface board is installed, the result will be printed after the check.

It is not installed, the following will be displayed.

14: RS232C CHECK MODE
I/F PWB NOT CONNECT

The process will be ended after sounding of the error end buzzer.

15) Dept. passcode

The department passcode list is printed.

16) Conf. passcode

The confidential passcode list is printed.

Differing from printing of one box alone soon after registration, the confidential passcodes of all boxes are printed.

17) Print hold code

The print lockout passcode No. is printed.

18) Memory set mode

The set and dump list of the memory content is output.

- The address (8 digits (P) generally including the bank information is input, and the data of 2 digits is continuously input. Inputting is done in the hexadecimal mode. The ten-key is used for 0 thru 9, and the alphabetic keys A (RAPID01 thru 06) are used for A thru F.
- During data inputting, the address can be moved forward and backward one byte by one byte with "⌘" and "#". (The address prior to the address 0 is looped as the maximum address.)
- The Validity of the address is not checked. Accordingly, writing/ reading operations are possible in the address of the memory not assigned, the address of ROM and so on. (However, as practical, writing is not done, and the data content runs short each reading.)
Though writing is possible in the flash memory, a little time is required. It is also necessary to take care that the life of the flash memory is excessively shortened if much data is written in the flash memory. Since it may run away depending the written content, take minute care for the writing address.
- When the REPORT key is input, the memory dump list is produced from the displayed address (here, it is limited at the 16-byte boundary address (address with end 0) which does not exceed the specified address and is just in front.). The dump list is output to a maximum of 99 pages. If any data of one page can be repeatedly developed and printed, the list is sufficient. But it is not desired that the content of plural pages are developed in the memory once and are then printed. If the STOP key is pressed, it will pass to the diagnosis after the page which is now being printed is completed printed. If the address exceeds the maximum address, it will return to the address 0 and printing will be continued.

19) Motor aging

- Whether a document is present or not, the motor in the sending system is kept in rotation until the STOP key is pressed.
- The image quality selection key can be input during stop alone to set the rotation speed for the image quality. (Here, the speed for FINE is selected when the intermediate tone is specified.)
- The image quality for default at the start of execution is STD regardless of the image quality selection priority of the main body.
- For rotation, the ⌘ key "1" selects the 1-2 phase excitation, "2" selects the 2-phase excitation and "3" selects the micro step. It can not be changed during rotation. The 1-2 phase excitation is set as default.

20) Stamp aging

- It is impossible if any document is not set up.
- The document is fed at the 10 mm intervals, and is continuously stamped.
- The total number of stamps from entry of the mode is displayed on the screen.
- The ordinary operation aging which stamps a finish every document is executed in the ordinary copying mode.

21) Scanner set mode

- The reading width and motor drive conditions are set.

<Reading width>

- | |
|---|
| <ol style="list-style-type: none"> 1. Top margin 2. Bottom margin 3. Left adjustment (The left position alone is specified.) |
|---|

Specify the above values.

- Select the above items 1, 2 and 3 with the ⌘ and [#] keys, and set the values with the [←] and [→] keys. The values can be set in the range of +3.0 mm to -3.0 mm at the 0.1 mm intervals. While the [←] and [→] key is continuously pressed one second or more, the setting value is automatically increased/decreased (in the range between the upper and lower limits).
- Input the quality selection key, and the value will be respectively set corresponding to the selected image quality. Here, the intermediate tone is the same as for the setting value of FINE.
- ±0.0 mm is default for all.

<Drive conditions of motor>

- | |
|--|
| <ol style="list-style-type: none"> 4. Motor 5. Phase 6. Slow-up 7. Slow-down |
|--|

Specify the above values.

- Select the above items 4 thru 7 with the ⌘ and [#] keys, and select the setting value with the ten-key.

Setting values

- | |
|---|
| <ol style="list-style-type: none"> 4. 6 steps 5. Selection of one mode from 1-2 phase, 2-phase and micro step 6. 3 steps 7. 3 steps |
|---|

- Input the quality selection key, and the value will be respectively set corresponding to the selected image quality. Here, the intermediate tone is the same as for the setting value of FINE.
 1. TOP
 2. BOTTOM
 3. LEFT
 4. MOTOR
 5. PHASE
 6. SLOW UP
 7. SLOW DOWN

22) Dial test mode

The mode is used to inspect whether dialing is accurate in two kinds of dial modes ⌘. All data which can be dialed in this mode are automatically called up in both PB mode and DP mode.

When this mode is activated, the following operations will be automatically executed. Whether the dialed content is right or not is judged with the external instrument which is connected to the line cable.

- ① After shift to the FAX diagnosis mode, press RAPID 24. (Also switch the display with the ⌘ and [#] keys.)
- ② Press the START key.
- ③ Turn on CML, and dial the following in the PB mode.
1, 2, 3, 4, 5, 6, 7, 8, 9, ⌘, 0, #
- ④ Turn off CML 500 mS alone.
- ⑤ Dial the following in the DP mode.
1, 5, 9, 0
- ⑥ After dialing, turn off CML.

This mode uses the ordinary auto dial. (Accordingly, the signal sending time and minimum pause are all the same as ordinary.)

The measurement result in this mode is completely all the same as in the ordinary dial mode.

Moreover, the same process as above is also done in the dial test mode which is executed in the product check mode.

- The lines 1/2 operate simultaneously in this mode.

23) Copy diag mode

In order to shorten the process time during production, this mode is used to automatically switch the copy mode. Three menus are provided.

1. ① Set up two documents. (In case of two documents or more, there is no problem.)
- ② Press the START key.
- ③ Copy 1st document in the fine mode/density AUTO. (One sheet is printed in the ordinary copy mode.)
- ④ Copy 2nd (subsequential) document in the intermediate tone mode/density DARK. (In the ordinary copying mode, one sheet is printed when the RESOLUTION key is pressed three times.)

When copy test is tried during production or is checked in two modes (fine and intermediate tones), this mode is provided to reduce the troublesome work which makes the operator stand aside to change the mode. Accordingly, the fine and intermediate tones are merely switched, and the mode is not switched to another mode. (Input of the image quality/density key is invalid.)

2. Try the copy in the mode fixed at COPY REDUCE 95% and fine mode/density AUTO. At this time, don't change the soft key of COPY REDUCE. (Input of the image quality/density key is invalid.)
3. Continuously try the above items 1 and 2.

24) Signal send mode 2

The signals concerned with V.34 & V.8 are checked.

After this mode is activated, press the START key, and the signals will be sent in the following sequence.

It can be used to check the modem.

- The selection signal is sent out simultaneously from the lines 1/2 in this mode.

- [1] No signal
- [2] 33600BPS
- [3] 31200BPS
- [4] 28800BPS
- [5] 26400BPS
- [6] 24000BPS
- [7] 21600BPS
- [8] 19200BPS
- [9] 16800BPS
- [10] 14400BPS
- [11] 12000BPS
- [12] 9600BPS
- [13] 7200BPS
- [14] 4800BPS
- [15] 2400BPS
- [16] V. 21 0-300bps
- [17] ANSam

2-2. Print diagnosis

Rapid key 01: Area print mode

The effective printing area frame is printed in the specified sheet size.

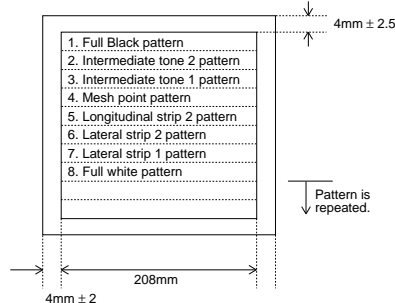

1. [Full black pattern]
2. [Intermediate tone 2 pattern]

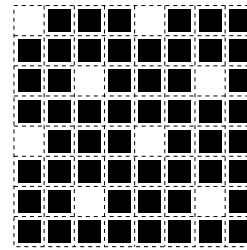

The left pattern is repeated.

3. [Intermediate tone 1 pattern]

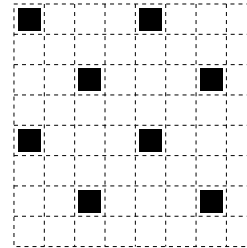

The left pattern is repeated.

4. [Mesh point pattern]

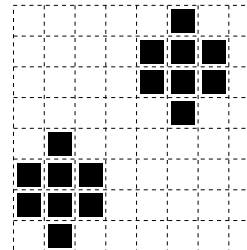

The left pattern is repeated.

5. [Longitudinal strip 2 pattern]

Black 2 dot and white 2 dot are repeated in line.

6. [Lateral strip 2 pattern]

Black 2 line and white 2 line are repeated.

7. [Lateral strip 1 pattern]

Black 1 line and white 1 line are repeated.

8. [Full White pattern]

Rapid key 02: Check pattern 1

The lateral stripe 2 pattern is printed on one sheet. (Black 2 line and white 2 line are repeated.)

Rapid key 03: Check pattern 2

The lateral stripe 2 pattern is printed on multiple pages. Press the STOP key to end the printing.

Rapid key 04: Check pattern 3

The intermediate tone 1 is printed on one sheet.

Rapid key 05: Paper feed aging

The mode is used for aging related to the printing. In this mode, the following modes are provided.

- ① Blank paper aging mode (ALL WHITE AGING)
- ② Whole black print aging mode (ALL BLACK AGING)
- ③ 5% printing aging mode (5% AGING)
- ④ 4% printing aging mode (4% AGING)

After selecting the paper-pass aging mode in the print diagnosis mode, input the number of each mode above with the ten-key, and the mode will be executed. The detailed specifications of each mode are described as follows. Here, the operation in each mode is stopped only when the STOP key is pressed by the operator or a printing-impossible error occurs.

- Blank paper aging mode
In the mode, printing is continued in the whole white (white paper) printing pattern until the STOP key is pressed by the operator. (In the printing area)
- Whole black printing aging mode
In the mode, printing is continued in the whole black (whole black) printing pattern until the STOP key is pressed by the operator. (In the printing area)

Rapid key 6: Bias adjust mode

The mode is used to adjust the printing density of the printed image. The image printing density is adjustable in six steps of 1 to 6.

For details, refer to the following table. (For selection, use the keys 1 thru 6.)

Image printing density	Thin ←					→ Thick
	1	2	3	4	5	6
Default value				0		

Rapid key 7: Life set mode

The mode is used to set the life counter of the printer and the counter of the auto feeder at desired values. For setting, proceed with the following procedure.

- When the life counter setting mode is selected, the following will be displayed.

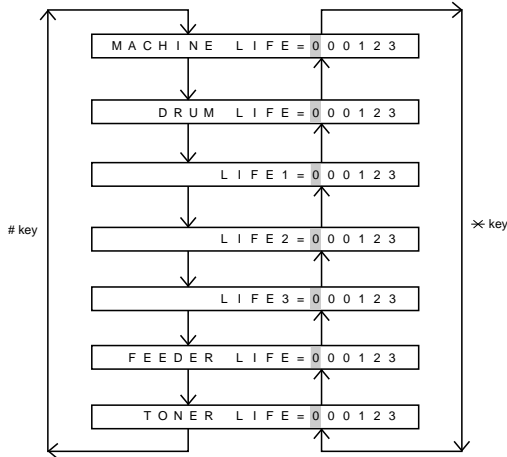

The cursor blinks at the top data.

Seven counters can be selected with the "#" and "x" keys.

- In the state ①, input a desired setting number of 6 digits with the ten-key.
- After input of 6 digits, shift to another counter with the "#" and "x" keys as necessary. When all necessary counters are completely input, press the START key.
- "STORED" will be displayed with the set values stored into the memory. For checking, retry this mode.

Note:

The counter shows the operational state of the printer (how many sheets have been printed since start of use? and others). The ordinary memory does not reset the counter. For clearing, set 0 in this mode or use the life counter clear mode in Item 3-9. (Accordingly, it is necessary to reset the counter or do the clear process in addition to the ordinary memory clear if the content in the memory on the control PWB is broken because of PWB repair, etc. (In the production stage, it is necessary to execute this in the last process.))

Rapid key 08: Life all clear

The mode is used to clear the life counter of the printer of the counter of the auto feeder.

Note: The counter shows the operational state of the printer (e.g. how many sheets have been printed since start of use?). The ordinary memory does not reset the counter. For clearing, set 0 in the mode 8 or execute this mode. (Accordingly, it is necessary to reset this counter in addition to the ordinary memory clear if the content in the memory on the control PWB is broken because of PWB repair, etc. (In the production stage, it is necessary to execute this in the last process.))

Rapid key 09: Life entry mode (For Serviceman temporary counter)

The mode is used to set a desired value for the judgment value (alarm judgment counter value) of the general purpose life counters 1 thru 3 of the printer. If the life of a consumable part (developer, imprinter, etc) is

set, the model which has the error display and RMS function will inform RMS when the counter reaches the set value. For setting, proceed with the following procedure.

- When the life counter setting mode is selected, the following will be displayed.

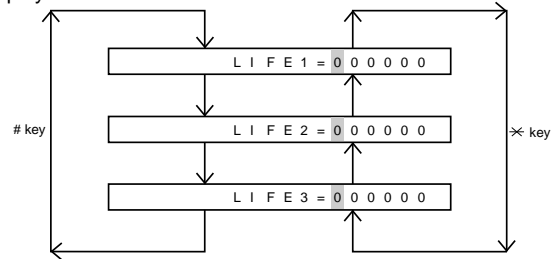

The cursor blinks at the top data.

Three counters can be selected with the "#" and "x" keys.

- In the state ①, input a desired setting number of 6 digits with the ten-key.
- After input of 6 digits, shift to another counter with the "#" and "x" keys as necessary. When all necessary counters are completely input, press the START key.
- "STORED" will be displayed with the set values stored into the memory. For checking, retry this mode.

Note: The counter shows the operational state of the printer (how many sheets have been printed since start of use? and others). The ordinary memory does not reset the counter. For clearing, set 0 in this mode or use the life counter clear mode in Item 3-9. (Accordingly, it is necessary to reset the counter or do the clear process in addition to the ordinary memory clear if the content in the memory on the control PWB is broken because of PWB repair, etc. (In the production stage, it is necessary to execute this in the last process.))

Rapid key 10: Top adjust mode

As the method to adjust the top margin for printing, adjust top-margin adjusting VR on the PWB. If this mode is used at this time, adjustment is possible without the printing test every time when VR is turned.

For the practical use, determine the adjusting value on the basis of the old data, and adjust to the determined value in this mode. Then, check it with the printing test.

Rapid key 11: Life clear mode

The mode is used to respectively clear the life counter of the printer and the counter of the auto feeder. For setting, proceed with the following procedure.

- When the life counter clearing mode is selected, the following will be displayed.

Seven counters can be selected with the "#" and "x" keys.

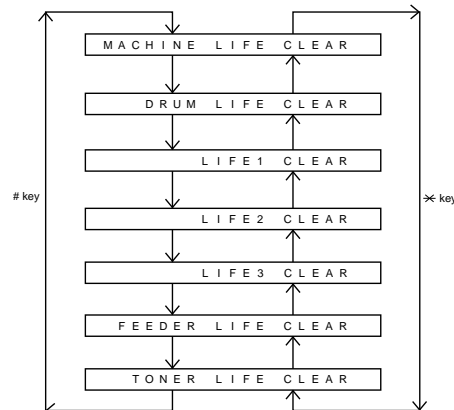

- In the state ①, input the CLEAR key, and the counter will be respectively cleared.
- After one clear, move the cursor to another counter with the "#" and "x" keys as necessary, and then press the CLEAR key. When the necessary counters are completely cleared, press the STOP key.

3. How to make soft switch setting

To enter the softswitch mode, make the following key entries in sequence.

Press **FUNCTION** **9** ***** **8** **#** **7** **START** **0 1** **START**

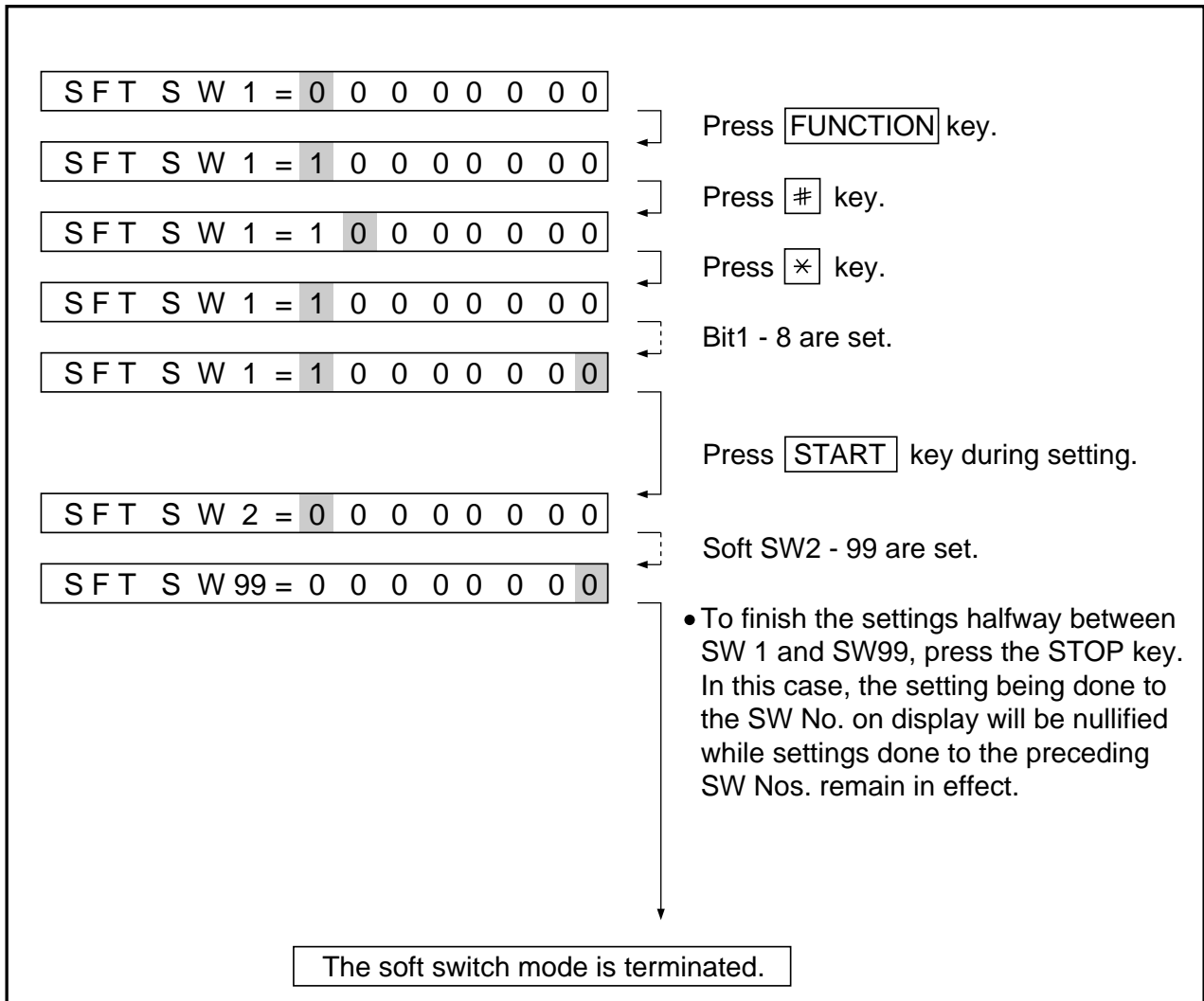

- SW1 to SW13: For line 1
- SW14 to SW26: For line 2

4. Soft switch description

• Soft switch

Note : SW1 to SW13 : For line 1, SW14 to SW26 : For line 2.

SW NO.	DATA NO.	ITEM	Switch setting and function					Initial setting	Remarks	
			1			0				
SW1	1	Recall interval	Binary input 8 4 2 1					0	OPTION Set to 1~15	
	2		No. = 1 2 3 4 (Data No.)					1		
	3		EX 0 1 0 1					0		
	4		eg. Recall interval is set to 5 min.					1		
	5	Recall attempts	Binary input 8 4 2 1					0	OPTION Set to 0~15	
	6		No. = 5 6 7 8 (Data No.)					0		
	7		EX 0 0 1 0					1		
	8		eg. Recall attempt times is set to 2 times.					0		
SW2	1	Dialing mode	PULSE			TONE		0		
	2	Receive mode	AUTO			MANUAL		1		
	3	ECM mode	Off			On		0	OPTION	
	4	Reserved						0		
	5	Polling security	On			Off		1	OPTION	
	6	Auto cover sheet	No			Yes		1	OPTION	
	7	JUNK-FAX function in manual reception	Yes			No		0		
	8	JUNK-FAX function	Yes			No		0	OPTION	
SW3	1	Number of rings for auto-receive (0: No ring receive)	Binary input 8 4 2 1					0	OPTION Set to 0~15	
	2		No. = 1 2 3 4 (Data No.)					0		
	3		EX 0 0 0 1					0		
	4		eg. Number of rings for auto receive is set to 1.					1		
	5	Switch to auto-receive from manual receive (0: No switch)	Binary input 8 4 2 1					0	OPTION Set to 0~15	
	6		No. = 5 6 7 8 (Data No.)					0		
	7		EX 0 0 0 0					0		
	8		eg. Switch to auto receive is set to disable.					0		
SW4		Communication results printout		Printed at error only	Printed at error/timer/memory only	Printed at transmission mode only	Not printed	Printed every time	OPTION	
	1		No. 1	0	0	0	1	1		0
	2		No. 2	0	0	1	0	1		0
	3		No. 3	1	0	0	0	0		1
	4	Image addition function to the communication result table (for memory transmission only)	On			Off		1	OPTION	
	5	Reserved						0		
	6	TEL billing code function	On			Off		0	OPTION	
	7	Billing code position	Before			After		1	OPTION	
8	Multi-TTI feature	On			Off		0	OPTION		
SW5	1	Time display format	24 hours			12 hours-AM/PM		0		
	2	Date display format	Month-Day-Year			Day-Month-Year		1		
	3	Header print	Off			On		0		
	4	Footer print	On			Off		0		
	5	Relay data output	No			Yes		0		
	6	Substitute reception	Off			On		0		
	7	Substitute reception conditions	Reception disable without TSI			Reception enable without TSI		0		
	8	CSI transmission	Off			On		0		

SW NO.	DATA NO.	ITEM	Switch setting and function					Initial setting	Remarks	
			1		0					
SW6	1	MH fixed	Yes		No (depend on remote machine)			0		
	2	H2 mode	No		Yes			0		
	3	Reserved						0		
	4	Reserved						0		
	5	Modem speed (DCS data reception speed)		V. 33 14400 12000	V. 17 14400 12000 9600 7200	V. 29 9600 7200	V. 27ter 4800 2400	1 0 0 0	Default 14400 BPS MODEM machine-1000 (V. 17-14400)	
	6		No. 5	0 0	1 1 1 1	0 0	0 0			
	7		No. 6	1 1	0 0 0 0	0 0	0 0			
	8		No. 7	0 1	0 1 0 1	0 1	1 0			
		No. 8	0 0	0 0 1 1	1 1	0 0				
SW7	1	Reception speed fixed			NO	V. 17- 14400BPS	V. 29- 9600BPS	V. 27ter- 4800BPS	0 0	When 14400BPS MODEM used, setting to 14400BPS is ignore.
	2		No. 1	0	1	0	1			
		No. 2	0	1	1	0				
	3	DIS receive acknowledge in G3 transmission	Twice		Once in NSF reception, twice in DIS reception			0	Effective to international comm.	
	4	Non-modulated carrier in V.29 transmission mode	On		Off			0		
	5	EOL detection timer	25sec		13sec			0		
	6	Protocol monitor	On		Off			0		
	7	Line monitor	On		Off			0		
8	Max. length for TX/RX/Copy	TX: 432mm, RX: unlimited		TX/Copy: 432mm, RX: 1.5m			0			
SW8	1	Compromise Equalizer			constant (ROM)		variable (SRAM)		0 1	
	2			No Filter	1.8Km	3.6Km	7.2Km			
		No. 1	0	0	1	1				
		No. 2	0	1	0	1				
	3	Reserved						0		
	4	Pause time	2 sec (1 sec from the second pause)		4 sec (2 sec from the second pause)			0		
	5	Signal transmission level	Binary input		8	4	2	1	1	
	6		No. =	5	6	7	8	(Data No.)	0	
7	EX		1	0	1	0		1		
8	Set to $-(n+3)$ dBm eg. Signal transmission level is set to -11dBm							0		

SW NO.	DATA NO.	ITEM	Switch setting and function				Initial setting	Remarks		
			1		0					
SW9	1	CED tone signal interval	500ms		75ms		0			
	2	CI signal OFF detect enable time	350ms or more		700ms or more		0			
	3	Equalizer freeze	On		Off		0			
	4	Equalizer freeze conditions	All		7200bps		0			
	5	Reserved					0			
	6	CED detection time	500ms		1000ms		0			
	7	Reserved					0			
	8	Reserved					0			
SW10	1	Reserved					0			
	2	Reserved					0			
	3	Reserved					0			
	4	Reserved					0			
	5	Distinctive ringing		OFF	STANDARD	RING1	RING2	RING3	0	
	6		No. 5	0	0	1	0	1		
	7		No. 6	0	0	0	1	1		
	8		No. 7	0	0	0	0	0		
		No. 8	0	1	0	0	0			
SW11	1	Memory retransmission times	Binary input 8 4 2 1				1	OPTION		
	2		No. = 1 2 3 4 (Data No.)							
	3		EX 1 0 1 0							
	4		eg. Retransmission time set to 10 times.							
	5	Memory retransmission interval	Binary input 8 4 2 1				0	OPTION		
	6		No. = 5 6 7 8 (Data No.)							
	7		EX 0 0 0 0							
	8		eg. Retransmission interval set to 5 min.							
SW12	1	Reserved					0			
	2	Reserved					0			
	3	Alarm buzzer		3sec	1sec	No BEEP	No BEEP	0		
	4		No. 3	0	0	1	1			
			No. 4	0	1	0	1			
	5	Action when RTN received	Handle to no error		Handle to error		0			
	6	V.34 mode function in case of manual communication	On		Off		1			
	7	V.34 mode function	On		Off		1			
8	V.34 control channel communication speed	2400bps		1200bps		0				
SW13	1	V.34 mode sending speed	Sending speed = 2400 (bps) x N				1			
	2		Example:							
	3		2400 (bps) x 12 = 28800 (bps)							
	4		2400 (bps) is set for N = 0. 33600 (bps) is set for N = 15.							
	5	V.34 mode receiving speed	Receiving speed = 2400 (bps) x N				1			
	6		Example:							
	7		2400 (bps) x 12 = 28800 (bps)							
	8		2400 (bps) is set for N = 0. 33600 (bps) is set for N = 15.							
SW14	1	Reserved					0			
	2	Reserved					1			
	3	Reserved					0			
	4	Reserved					1			
	5	Reserved					0			
	6	Reserved					0			
	7	Reserved					1			
	8	Reserved					0			

SW NO.	DATA NO.	ITEM	Switch setting and function				Initial setting	Remarks		
			1		0					
SW15	1	Dialing mode	PULSE		TONE		0			
	2	Reserved					1			
	3	Reserved					0			
	4	Reserved					0			
	5	Reserved					1			
	6	Reserved					1			
	7	Reserved					0			
	8	Reserved					0			
SW16	1	Number of rings for auto-receive	Binary input 8 4 2 1				0	OPTION Set to 0 ~15		
	2	(0 : No ring receive)	No. = 1 2 3 4 (Data No.)				0			
	3		EX 0 0 0 1				0			
	4		eg. Number of rings for auto receive is set to 1.				1			
	5	Reserved					0			
	6	Reserved					0			
	7	Reserved					0			
	8	Reserved					0			
SW17	1	Reserved					0			
	2	Reserved					0			
	3	Reserved					1			
	4	Reserved					1			
	5	Reserved					0			
	6	Reserved					0			
	7	Reserved					1			
	8	Reserved					0			
SW18	1	Reserved					0			
	2	Reserved					1			
	3	Reserved					0			
	4	Reserved					0			
	5	Reserved					0			
	6	Reserved					0			
	7	Reserved					0			
	8	Reserved					0			
SW19	1	Reserved					0			
	2	Reserved					0			
	3	Reserved					0			
	4	Reserved					0			
	5	Modem speed (DCS data reception speed)		V. 33 14400 12000	V. 17 14400 12000 9600 7200	V. 29 9600 7200	V. 27ter 4800 2400	1 0 0 0	Default 14400 BPS MODEM machine-1000 (V. 17-14400)	
	6		No. 5	0 0	1 1 1 1	0 0	0 0			
	7		No. 6	1 1	0 0 0 0	0 0	0 0			
	8		No. 7	0 1	0 1 0 1	0 1	1 0			
		No. 8	0 0	0 0 1 1	1 1	0 0				
SW20	1	Reception speed fixed			NO	V. 17- 14400PS	V. 29- 9600BPS	V. 27ter- 4800BPS	0 0	When 14400BPS MODEM used, setting to 14400BPS is ignore.
	2		No. 1		0	1	0	1		
			No. 2		0	1	1	0		
	3	DIS receive acknowledge in G3 transmission	Twice			Once in NSF reception, twice in DIS reception			0	Effective to international comm.
	4	Non-modulated carrier in V.29 transmission mode	On			Off			0	
	5	EOL detection timer	25sec			13sec			0	
	6	Protocol monitor	On			Off			0	
	7	Line monitor	On			Off			0	
8	Reserved							0		

SW NO.	DATA NO.	ITEM	Switch setting and function					Initial setting	Remarks	
			1		0					
SW21	1	Compromise Equalizer			constant (ROM)		variable (SRAM)		0	
					No Filter	1.8Km	3.6Km	7.2Km		
	2		No. 1	0	0	1	1	1		
	3	Reserved						0		
	4	Pause time	2 sec (1 sec from the second pause)	4 sec (2 sec from the second pause)				0		
	5	Signal transmission level	Binary input 8 4 2 1					1		
	6		No. = 5 6 7 8 (Data No.)					0		
	7		EX 1 0 1 0					1		
8		Set to -(n+3)dBm eg. Signal transmission level is set to -11dBm					0			
SW22	1	CED tone signal interval	500ms		75ms			0		
	2	CI signal OFF detect enable time	350ms or more		700ms or more			0		
	3	Equalizer freeze	On		Off			0		
	4	Equalizer freeze conditions	All		7200bps			0		
	5	Reserved						0		
	6	CED detection time	500ms		1000ms			0		
	7	Reserved						0		
	8	Reserved						0		
SW23	1	Reserved						0		
	2	Reserved						0		
	3	Reserved						0		
	4	Reserved						0		
	5	Distinctive ringing		OFF	STANDARD	RING1	RING2	RING3	0	
	6		No. 5	0	0	1	0	1	0	
	7		No. 6	0	0	0	1	1	0	
	8		No. 7	0	0	0	0	0	0	
		No. 8	0	1	0	0	0	0		
SW24	1	Reserved						1		
	2	Reserved						0		
	3	Reserved						1		
	4	Reserved						0		
	5	Reserved						0		
	6	Reserved						0		
	7	Reserved						0		
	8	Reserved						0		
SW25	1	Reserved						0		
	2	Reserved						0		
	3	Reserved						0		
	4	Reserved						0		
	5	Reserved						0		
	6	Reserved						1		
	7	V.34 mode function	On		Off			1		
	8	V.34 control channel communication speed	2400bps		1200bps			0		
SW26	1	V.34 mode sending speed	Sending speed = 2400 (bps) x N					1		
	2		Example:					1		
	3		2400 (bps) x 12 = 28800 (bps)					1		
	4		2400 (bps) is set for N = 0.					0		
			33600 (bps) is set for N = 15.							
	5	V.34 mode receiving speed	Receiving speed = 2400 (bps) x N					1		
	6		Example:					1		
	7		2400 (bps) x 12 = 28800 (bps)					1		
8		2400 (bps) is set for N = 0.					0			
		33600 (bps) is set for N = 15.								

SW NO.	DATA NO.	ITEM	Switch setting and function								Initial setting	Remarks	
			1				0						
SW27	1 2 3	Line condition setting	Line 1	TX/RX	TX/RX	TX/RX	RX	RX	TX	TX	0 0 0	OPTION	
			Line 2	TX/RX	RX	TX	TX/RX	TX	TX/RX	RX			
			No. 1	0	0	0	0	1	1	1			
			No. 2	0	0	1	1	0	0	1			
		No. 3	0	1	0	1	0	1	0				
	4	Preference line specification	LINE 2				LINE 1				0		
	5 6	Key buzzer volume			Off	HIGH	MIDDLE	LOW			1 1		
	No. 5		0	0	1	1							
	No. 6	0	1	0	1								
7	Reserved									0			
8	Reserved									0			
SW28	1 2	Speaker volume			HIGH	HIGH	MIDDLE	LOW			1 1		
			No. 1	0	0	1	1						
		No. 2	0	1	0	1							
	3 4	Handset volume			HIGH	HIGH	MIDDLE	LOW			1 0		
			No. 3	0	0	1	1						
		No. 4	0	1	0	1							
	5 6	Ringer volume			Off	HIGH	MIDDLE	LOW			1 1		
			No. 5	0	0	1	1						
		No. 6	0	1	0	1							
	7	Reserved									0		
8	Reserved									0			
SW29	1	Line to be used in PC I/F mode	LINE 2				LINE 1				0		
	2	PC I/F mode	On				Off				0	OPTION	
	3	Auto receive with PC I/F	PC				FAX				0	OPTION	
	4	Reserved									0		
	5	Reserved									0		
	6	Reserved									0		
	7	Reserved									0		
	8	Reserved									0		
SW30	1	Reserved									0		
	2	Reserved									0		
	3	Continuous serial polling	On				Off				0		
	4 5	Dialing interval in continuous serial polling		0minute	30minutes	60minutes	120minutes					0 0	When SW30-3 is ON to be set by OPTION setting
			No. 4	0	0	1	1						
		No. 5	0	1	0	1							
	6	Reserved									0		
7	Reserved									0			
8	Quick on-line	Yes				No				1			
SW31	1	Reserved									0		
	2	Reserved									0		
	3	Reserved									0		
	4	Reserved									0		
	5	Reserved									1		
	6	Reserved									0		
	7	Reserved									1		
	8	Reserved									0		

SW NO.	DATA NO.	ITEM	Switch setting and function							Initial setting	Remarks			
			1				0							
SW32	1	Print hold	On				Off			0	OPTION			
	2	Document transmission in Super G3 mode	Yes				No			0	Refer to Page 2-44.			
	3	Reserved								0				
	4	Changeover of print cassette	On				Off			1	OPTION			
	5	Selection of print cassette	W cassette	Auto.	TUL	TLU	UTL	ULT	LTU	LUT	0	Indicate of priority T...TRAY U...UPPER L...LOWER		
			No. 5	0	1	1	0	0	0	0				
			No. 6	0	0	0	1	1	0	0				
			No. 7	0	0	0	0	0	1	1				
	8	No. 8	0	1	0	1	0	1	0	0				
	5	Selection of print cassette	SEPA. MODE ON	Auto.	U→L	L→U	Work in auto mode except in this table.				0	Indicate of priority U...UPPER L...LOWER		
			No. 5	0	0	0								
			No. 6	0	1	0								
			No. 7	0	0	1								
	8	No. 8	0	0	0					0				
SW33	1	Heater mode			Always on		Always off		Off timer		0	OPTION		
			No. 1	0		0		1						
	2		No. 2	0		1		0		1				
	3	Density adjustment of print bias	Binary input		4	2	1						0	set to 1~6. set to 0,7 is equal to 3 (001).
			No. =	3	4	5	(Data No.) 1: faint 6: deep							
			EX	0	1	1								
	5		eg. Bias is set to level 3.									1		
	6	Drum life limit	0 near = 19,000 pcs. 0 near = 15,000 pcs. 1 near = 15,000 pcs. 1 near = 16,000 pcs.									0		
7		0 limit = 20,000 pcs. 1 limit = 16,000 pcs. 0 limit = 20,000 pcs. 1 limit = 20,000 pcs.									0			
8	Reserved										0			
SW34	1	Start time of heater OFF timer (Upper digit of hour)	Binary input		8	4	2		1		0	OPTION		
			No. =	1	2	3	4		(Data No.)					
			EX	0	0	0	0							
	5	Start time of heater OFF timer (Lower digit of hour)	Binary input		8	4	2		1		0	OPTION		
			No. =	5	6	7	8		(Data No.)					
			EX	0	0	0	0							
			eg. Start time is set to 15: XX											
SW35	1	Start time of heater OFF timer (Upper digit of minute)	Binary input		8	4	2		1		0	OPTION		
			No. =	1	2	3	4		(Data No.)					
			EX	0	0	0	0							
5	Start time of heater OFF timer (Lower digit of minute)	Binary input		8	4	2		1		0	OPTION			
		No. =	5	6	7	8		(Data No.)						
		EX	0	0	0	0								
		eg. Start time is set to XX: 40												
SW36	1	End time of heater OFF timer (Upper digit of hour)	Binary input		8	4	2		1		0	OPTION		
			No. =	1	2	3	4		(Data No.)					
			EX	0	0	0	0							
5	End time of heater OFF timer (Lower digit of hour)	Binary input		8	4	2		1		0	OPTION			
		No. =	5	6	7	8		(Data No.)						
		EX	0	0	0	0								
		eg. End time is set to 21: XX												

SW NO.	DATA NO.	ITEM	Switch setting and function				Initial setting	Remarks		
			1		0					
SW37	1	End time of heater OFF timer (Upper digit of minute)	Binary input	8	4	2	1	0	OPTION	
	2		No. =	1	2	3	4	(Data No.)		0
	3		EX	0	0	0	0	0		
	4							0		
	5	End time of heater OFF timer (Lower digit of minute)	Binary input	8	4	2	1	0	OPTION	
	6		No. =	5	6	7	8	(Data No.)		0
	7		EX	0	0	0	0	0		
	8			eg. End time is set to XX: 35				0		
SW38	1	Reserved					1			
	2	Reserved					0			
	3	Reserved					0			
	4	Reserved					0			
	5	Reserved					0			
	6	Reserved					0			
	7	Reserved					0			
	8	Reserved					0			
SW39	1	Reserved					0			
	2	Reserved					1			
	3	Reserved					0			
	4	Reserved					0			
	5	Reserved					0			
	6	Reserved					0			
	7	Reserved					0			
	8	Reserved					0			
SW40	1	Reserved					1			
	2	Reserved					0			
	3	Reserved					0			
	4	Reserved					0			
	5	Reserved					0			
	6	Reserved					0			
	7	Reserved					0			
	8	Reserved					0			
SW41	1	Reserved					0			
	2	Reserved					0			
	3	Reserved					1			
	4	Reserved					0			
	5	Reserved					0			
	6	Reserved					1			
	7	Reserved					0			
	8	Reserved					1			

SW NO.	DATA NO.	ITEM	Switch setting and function					Initial setting	Remarks		
			1		0						
SW42	1	Reserved						0			
	2	Reserved						0			
	3	Reserved						1			
	4	Reserved						0			
	5	Reserved						0			
	6	Reserved						1			
	7	Reserved						0			
	8	Reserved						1			
SW43	1	Reserved						1			
	2	Reserved						0			
	3	Reserved						0			
	4	Reserved						0			
	5	Reserved						0			
	6	Reserved						1			
	7	Reserved						0			
	8	Reserved						1			
SW44	1	Automatic printing of activity report	Yes (When memory full)		No (First data is cleared when memory full)			0	OPTION		
	2	Printout of total time and total number of pages on activity report	Off		On			0			
	3	Reserved						0			
	4	Department function	On		Off			0			
	5	Department ID digit	Binary input					0	OPTION Set is 3~9.		
	6		No. = 8 4 2 1					1			
	7		EX 5 6 7 8 (Data No.)					0			
	8		0 1 0 0 eg. Department ID is set to 4 digits.					0			
SW45	1	Picture quality priority mode	Fine		Standard			0	OPTION		
	2	Cut-off mode (when copy mode)	Continue		Cut-off			0	OPTION		
	3	Scanning ratio in memory input	1 : 1		Reduce			0	Memory scanning		
	4	Verification STAMP	Yes		No			0	Invalid if not mounted.		
	5	Overseas communication mode selection function	Yes		No			0	Refer to Page 2-44.		
	6	Reduce ratio (when copy mode)			AUTO	100%	95%	89%	74%	1	
	7				No. 6	0	1	0	0		1
	8				No. 7	0	0	1	0		1
				No. 8	0	0	0	1	0		

SW NO.	DATA NO.	ITEM	Switch setting and function					Initial setting	Remarks
			1		0				
SW46	1	Reserved						0	
	2	Reserved						0	
	3	Density adjustment (when Fine/STD mode)		Normal	Faint	Deep	Deep (when Dark mode)	0	
			No. 1	0	0	1	1		
	4		No. 2	0	1	0	1	0	
				Normal	Faint	Deep	Deep (when Dark mode)	0	
	5	Density adjustment (when Half-tone mode)	No. 3	0	0	1	1		
			6		No. 4	0	1	0	1
7	HTF correction in Half-tone mode	On			Off			1	
8	MTF correction in Half-tone mode	Strong		Weak			0		
SW47	1	Reserved						0	
	2	Reserved						0	
	3	Reserved						0	
	4	Reserved						0	
	5	Reserved						0	
	6	Reserved						0	
	7	Reserved						0	
	8	Reserved						0	
SW48	1	Reserved						0	
	2	Reserved						0	
	3	Reserved						0	
	4	Reserved						0	
	5	Reserved						0	
	6	Reserved						0	
	7	Reserved						0	
	8	Reserved						0	
SW49	1	Reserved						0	
	2	Reserved						0	
	3	Reserved						0	
	4	Reserved						0	
	5	Reserved						0	
	6	Reserved						0	
	7	Reserved						0	
	8	Reserved						0	
SW50	1	Reserved						0	
	2	Reserved						0	
	3	Reserved						0	
	4	Reserved						0	
	5	Reserved						0	
	6	Reserved						0	
	7	Reserved						0	
	8	Reserved						0	
SW51	1	Reserved						0	
	2	Reserved						0	
	3	Reserved						0	
	4	Reserved						0	
	5	Reserved						0	
	6	Reserved						0	
	7	Reserved						0	
	8	Reserved						0	

SW NO.	DATA NO.	ITEM	Switch setting and function					Initial setting	Remarks	
			1		0					
SW52	1	Reserved						0		
	2	Reserved						0		
	3	Reserved						0		
	4	Reserved						0		
	5	Reserved						0		
	6	Reserved						0		
	7	Reserved						0		
	8	Reserved						0		
SW53	1	Reserved						0		
	2	Reserved						0		
	3	Reserved						0		
	4	Reserved						0		
	5	Reserved						0		
	6	Reserved						0		
	7	Reserved						0		
	8	Reserved						0		
SW54	1	Reserved						0		
	2	Reserved						0		
	3	Reserved						0		
	4	Reserved						0		
	5	Reserved						0		
	6	Reserved						0		
	7	Reserved						0		
	8	Reserved						0		
SW55	1	Reserved						0		
	2	Reserved						0		
	3	Reserved						0		
	4	Reserved						0		
	5	Reserved						0		
	6	Reserved						0		
	7	Reserved						0		
	8	Reserved						0		
SW56	1	Reserved						1		
	2	Reserved						1		
	3	Reserved						1		
	4	Reserved						1		
	5	Printing when toner empty	Printing		Stop			0		
	6	Reduction of print data		AUTO	100%	94%(92%)	88%(86%)	73%(72%)	0	The number in () is applicable for the footer print on. AUTO is equivalent to 100%.
	7		No. 6	0	1	0	0	1	0	
	8		No. 7	0	0	1	0	1	0	
	No. 8	0	0	0	1	0	0			
SW57	1	Reserved						0		
	2	Reserved						0		
	3	Reserved						0		
	4	Reserved						0		
	5	Reserved						0		
	6	Reserved						0		
	7	Reserved						0		
	8	Reserved						0		

SW NO.	DATA NO.	ITEM	Switch setting and function		Initial setting	Remarks
			1	0		
SW58	1	Reserved			0	
	2	Reserved			0	
	3	Reserved			0	
	4	Reserved			0	
	5	Reserved			0	
	6	Reserved			0	
	7	Reserved			0	
	8	Reserved			0	
SW59	1	Reserved			0	
	2	Reserved			0	
	3	Reserved			0	
	4	Reserved			0	
	5	Reserved			0	
	6	Reserved			0	
	7	Reserved			0	
	8	Reserved			0	
SW60	1	Reserved			0	
	2	Reserved			0	
	3	Reserved			0	
	4	Reserved			0	
	5	Reserved			0	
	6	Reserved			0	
	7	Reserved			0	
	8	Reserved			0	
SW61	1	Reserved			0	
	2	Reserved			0	
	3	Reserved			0	
	4	Reserved			0	
	5	Reserved			0	
	6	Reserved			0	
	7	Reserved			0	
	8	Reserved			0	
SW62	1	Reserved			0	
	2	Reserved			0	
	3	Reserved			0	
	4	Reserved			0	
	5	Reserved			0	
	6	Reserved			0	
	7	Reserved			0	
	8	Reserved			0	
SW63	1	Reserved			0	
	2	Reserved			0	
	3	Reserved			0	
	4	Reserved			0	
	5	Reserved			0	
	6	Reserved			0	
	7	Reserved			0	
	8	Reserved			0	

SW NO.	DATA NO.	ITEM	Switch setting and function		Initial setting	Remarks
			1	0		
SW64	1	Reserved			0	
	2	Reserved			0	
	3	Reserved			0	
	4	Reserved			0	
	5	Reserved			0	
	6	Reserved			0	
	7	Reserved			0	
	8	Reserved			0	
SW65	1	Reserved			0	
	2	Reserved			0	
	3	Reserved			0	
	4	Reserved			0	
	5	Reserved			0	
	6	Reserved			0	
	7	Reserved			0	
	8	Reserved			0	
SW66	1	Reserved			0	
	2	Reserved			0	
	3	Reserved			0	
	4	Reserved			0	
	5	Reserved			0	
	6	Reserved			0	
	7	Reserved			0	
	8	Reserved			0	
SW67	1	Reserved			0	
	2	Reserved			0	
	3	Reserved			0	
	4	Reserved			0	
	5	Reserved			0	
	6	Reserved			0	
	7	Reserved			0	
	8	Reserved			0	
SW68	1	Reserved			0	
	2	Reserved			0	
	3	Reserved			0	
	4	Reserved			0	
	5	Reserved			0	
	6	Reserved			0	
	7	Reserved			0	
	8	Reserved			0	
SW69	1	Cassette define (LTR/A4): Tray	A4	LTR	0	
	2	Cassette define (LTR/A4): Upper	A4	LTR	0	When W cassette
	3	Cassette define (LTR/A4): Lower	A4	LTR	0	Ignore when W cassette.
	4	Separation of image area in the half-tone	On	Off	1	
	5	Removal of notch in the binary mode	On	Off	1	
	6	Reserved			1	
	7	Reserved			1	
	8	Reserved			0	

SW NO.	DATA NO.	ITEM	Switch setting and function							Initial setting	Remarks				
			1			0									
SW70	1	Reserved								1					
	2	Reserved								1					
	3	Reserved								1					
	4	Reserved								1					
	5	Reserved								0					
	6	Reserved								0					
	7	Reserved								0					
	8	Reserved								0					
SW71	1 2 3 4	Black line detection (When transmission scanning)	Continued black line count when detected							0 0 1 1					
				1	2	3	4	5	6			7	Unused		
			No. 1	0	0	0	0	0	0			0	0		
			No. 2	0	0	0	0	1	1			1	1		
			No. 3	0	0	1	1	0	0			1	1		
	No. 4	0	1	0	1	0	1	0	1						
	5 6 7 8	All white page detection (When transmission scanning)	All white line count ratio against total count of page to judge the white page							0 1 0 1					
				Unused	1.0%	1.5%	2.0%	2.5%	3.0%			3.5%	4.0%		
			No. 5	0	0	0	0	0	0			0	0		
			No. 6	0	0	0	0	1	1			1	1		
			No. 7	0	0	1	1	0	0			1	1		
			No. 8	0	1	0	1	0	1			0	1		
			5 6 7 8	All white line count ratio against total count of page to judge the white page	All white line count ratio against total count of page to judge the white page										
						4.5%	5.0%	5.5%	6.0%					7.0%	8.0%
	No. 5	1			1	1	1	1	1	1	1				
	No. 6	0			0	0	0	1	1	1	1				
No. 7	0	0			1	1	0	0	1	1					
No. 8	0	1			0	1	0	1	0	1					
SW72	1 2 3 4	Black line detection (When copy scanning)			Continued black line count when detected									0 0 1 1	
						1	2	3	4	5	6				
			No. 1	0	0	0	0	0	0	0	0				
			No. 2	0	0	0	0	1	1	1	1				
			No. 3	0	0	1	1	0	0	1	1				
	No. 4	0	1	0	1	0	1	0	1						
	5 6 7 8	White page detect (When copy scanning)	All white line count ratio against total count of page to judge the white page							0 1 0 1					
				Unused	1.0%	1.5%	2.0%	2.5%	3.0%			3.5%	4.0%		
			No. 5	0	0	0	0	0	0			0	0		
			No. 6	0	0	0	0	1	1			1	1		
			No. 7	0	0	1	1	0	0			1	1		
			No. 8	0	1	0	1	0	1			0	1		
			5 6 7 8	All white line count ratio against total count of page to judge the white page	All white line count ratio against total count of page to judge the white page										
						4.5%	5.0%	5.5%	6.0%					7.0%	8.0%
	No. 5	1			1	1	1	1	1	1	1				
	No. 6	0			0	0	0	1	1	1	1				
No. 7	0	0			1	1	0	0	1	1					
No. 8	0	1			0	1	0	1	0	1					
SW73	1	Reserved												1	
	2	Reserved												0	
	3	Reserved								0					
	4	Reserved								0					
	5	Reserved								0					
	6	Reserved								0					
	7	Reserved								0					
	8	Reserved								1					

SW NO.	DATA NO.	ITEM	Switch setting and function		Initial setting	Remarks
			1	0		
SW74	1	Reserved			0	
	2	Reserved			1	
	3	Reserved			1	
	4	Reserved			0	
	5	Reserved			0	
	6	Reserved			0	
	7	Reserved			0	
	8	Reserved			0	
SW75	1	Reserved			0	
	2	Reserved			1	
	3	Reserved			0	
	4	Reserved			0	
	5	Reserved			0	
	6	Reserved			0	
	7	Reserved			0	
	8	Reserved			0	
SW76	1	Reserved			1	
	2	Reserved			1	
	3	Reserved			1	
	4	Reserved			1	
	5	Reserved			1	
	6	Reserved			1	
	7	Reserved			0	
	8	Reserved			0	
SW77	1	Reserved			0	
	2	Reserved			0	
	3	Reserved			0	
	4	Reserved			0	
	5	Reserved			0	
	6	Reserved			0	
	7	Reserved			0	
	8	Reserved			0	
SW78	1	Secure billing code	Yes	No	0	
	2	Pause with Z key	Yes	No	0	Only when special billing code is given.
	3	Reserved			0	
	4	Z key pause time	Binary input 16 8 4 2 1		0	Only when the special billing code is given The ordinary pause is not affected.
	5	250 ms unit	No. = 4 5 6 7 8 (Data No.)		0	
	6		EX 0 0 0 0 0		0	
	7		eg. Pause time 250 ms		0	
	8		Time = (n + 1) x 250 ms		0	
SW79	1	Reserved			1	
	2	Reserved			1	
	3	Reserved			1	
	4	Reserved			1	
	5	Reserved			0	
	6	Reserved			0	
	7	Reserved			0	
	8	Reserved			0	

SW NO.	DATA NO.	ITEM	Switch setting and function		Initial setting	Remarks
			1	0		
SW80	1	Reserved			0	
	2	Reserved			0	
	3	Reserved			1	
	4	Reserved			1	
	5	Reserved			0	
	6	Reserved			1	
	7	Reserved			1	
	8	Reserved			0	
SW81	1	Reserved			0	
	2	Reserved			0	
	3	Reserved			0	
	4	Reserved			0	
	5	Reserved			1	
	6	Reserved			0	
	7	Reserved			0	
	8	Reserved			0	
SW82	1	Reserved			1	
	2	Reserved			0	
	3	Reserved			0	
	4	Reserved			1	
	5	Reserved			0	
	6	Reserved			0	
	7	Reserved			1	
	8	Reserved			1	
SW83	1	Reserved			0	
	2	Reserved			1	
	3	Reserved			0	
	4	Reserved			0	
	5	Reserved			0	
	6	Reserved			1	
	7	Reserved			1	
	8	Reserved			0	
SW84	1	Reserved			0	
	2	Reserved			0	
	3	Reserved			1	
	4	Reserved			0	
	5	Reserved			0	
	6	Reserved			0	
	7	Reserved			0	
	8	Reserved			1	
SW85	1	Reserved			0	
	2	Reserved			0	
	3	Reserved			1	
	4	Reserved			0	
	5	Reserved			0	
	6	Reserved			0	
	7	Reserved			0	
	8	Reserved			1	

SW NO.	DATA NO.	ITEM	Switch setting and function					Initial setting	Remarks
			1		0				
SW86	1	F.A.S.T. (RMS) mode	On		Off			0	
	2	F.A.S.T. (RMS) line	LINE 2		LINE 1			0	
	3	Day light saving time feature	On		Off			0	
	4	Separate mode	On		Off			0	OPTION
	5	Reserved						0	
	6	Reserved						0	
	7	CNG send when manual TX	On		Off			1	
	8	Ringer of line 2	On		Off			0	
SW87	1	Reserved						0	
	2	Addition of header to various lists		Without addition	Information of line 1	Information of line 2	Without addition	0	
	3		No. 2	0	0	1	1		
	3		No. 3	0	1	0	1		
	4	Relay instruction transmission line specification		AUTO	Line 1	Line 2	Not used (AUTO)	0	
	5		No. 4	0	0	1	1		
	5		No. 5	0	1	0	1		
	6	Reserved						1	
7	Reserved						0		
8	Reserved						0		
SW88	1	Reserved						0	
	2	Reserved						1	
	3	Reserved						0	
	4	Reserved						0	
	5	Reserved						0	
	6	Reserved						0	
	7	Reserved						0	
	8	Reserved						0	
SW89	1	Reserved						0	
	2	Reserved						0	
	3	Reserved						0	
	4	Reserved						0	
	5	Reserved						0	
	6	Reserved						0	
	7	Reserved						0	
	8	Reserved						0	
SW90	1	Reserved						0	
	2	Reserved						0	
	3	Reserved						0	
	4	Reserved						0	
	5	Reserved						0	
	6	Reserved						0	
	7	Reserved						0	
	8	Reserved						0	
SW91	1	Reserved						0	
	2	Reserved						0	
	3	Reserved						0	
	4	Reserved						0	
	5	Reserved						0	
	6	Reserved						0	
	7	Reserved						0	
	8	Reserved						0	

SW NO.	DATA NO.	ITEM	Switch setting and function		Initial setting	Remarks
			1	0		
SW92	1	Reserved			0	
	2	Reserved			0	
	3	Reserved			0	
	4	Reserved			0	
	5	Reserved			0	
	6	Reserved			0	
	7	Reserved			0	
	8	Reserved			0	
SW93	1	Reserved			0	
	2	Reserved			0	
	3	Reserved			0	
	4	Reserved			0	
	5	Reserved			0	
	6	Reserved			0	
	7	Reserved			0	
	8	Reserved			0	
SW94	1	Reserved			0	
	2	Reserved			0	
	3	Reserved			0	
	4	Reserved			0	
	5	Reserved			0	
	6	Reserved			0	
	7	Reserved			0	
	8	Reserved			0	
SW95	1	Reserved			0	
	2	Reserved			0	
	3	Reserved			0	
	4	Reserved			0	
	5	Reserved			0	
	6	Reserved			0	
	7	Reserved			0	
	8	Reserved			0	
SW96	1	Reserved			0	
	2	Reserved			0	
	3	Reserved			0	
	4	Reserved			0	
	5	Reserved			0	
	6	Reserved			0	
	7	Reserved			0	
	8	Reserved			0	
SW97	1	Reserved			0	
	2	Reserved			0	
	3	Reserved			0	
	4	Reserved			0	
	5	Reserved			1	
	6	Reserved			1	
	7	Reserved			1	
	8	Reserved			1	

SW NO.	DATA NO.	ITEM	Switch setting and function		Initial setting	Remarks
			1	0		
SW98	1	Reserved			0	
	2	Reserved			0	
	3	Reserved			0	
	4	Reserved			0	
	5	Reserved			0	
	6	Reserved			0	
	7	Reserved			0	
	8	Reserved			0	
SW99	1	Reserved			0	
	2	Reserved			0	
	3	Reserved			0	
	4	Reserved			0	
	5	Reserved			0	
	6	Reserved			0	
	7	Reserved			0	
	8	Reserved			0	

• Soft switch function description

SW1 No. 1 ~ No. 4 Recall interval

Choice is made for a recall interval for speed and rapid dial-numbers. Use a binary number to program this. If set to 0 accidentally, 1 will be assumed.

SW1 No. 5 ~ No. 8 Recall attempts

Choice is made as to how many recall attempts should be made. Use a binary number to program this.

SW2 No. 1 Dialing mode

Switch the type according to the telephone circuit connected to the facsimile.

0: PULSE DIAL

1: TONE DIAL

SW2 No. 2 Receive mode

Auto/manual receiving mode is set.

SW2 No. 3 ECM mode

Used to determine ECM mode function. Refer to the following table.

SW2-No.3 ECM MODE	0	0	0	0	0	0	0	0	0	1	1	1	1	1	1	1	1
SW6-No.1 MH FIXED	0	1	0	1	0	1	0	1	0	1	0	1	0	1	0	1	1
Compression method	ECM MMR mode	Yes	No	Yes	No	No	No	No	No	No	No	No	No	No	No	No	No
	ECM MR mode	Yes	No	Yes	No	Yes	No	Yes	No	No	No	No	No	No	No	No	No
	ECM MMH mode	Yes	Yes	No	No	Yes	Yes	No	No	No	No	No	No	No	No	No	No
	ECM MH mode	Yes	Yes	Yes	Yes	Yes	Yes	Yes	Yes	No	No	No	No	No	No	No	No
	MR mode	Yes	No	Yes	No	Yes	No	Yes	No	Yes	No	Yes	No	Yes	No	Yes	No
	MH mode	Yes	Yes	Yes	Yes	Yes	Yes	Yes	Yes	Yes	Yes	Yes	Yes	Yes	Yes	Yes	Yes

(Depending on remote machine)

SW2 No. 4 Reserved

Set to "0".

SW2 No. 5 Polling security

This switch is employed to enable or disable the polling operation using the ID code verification function, in order to prevent unauthorized polling operation.

SW2 No. 6 Auto cover sheet

When "1" (=YES) is selected, the cover sheet is automatically sent after transmission of the original to notify the receiver of the number of original sheets transmitted.

SW2 No. 7 JNNK-FAX function in manual reception

It is set whether JUNK-FAX is functioned in the manual receiving mode or not.

SW2 No. 8 JUNK-FAX function

This function is used to receive data from a specific remote machine (station registered in entry mode). It is the function that refused a reception in the case that TSI of remote machine matched with fax number of the station registered.

0: No

1: Yes

SW3 No. 1 ~ No. 4 Number of rings for auto-receive (0: No ring receive)

When the machine is set in the auto receive mode, the number of rings before answering can be selected. It may be set from one to nine rings using a binary number. If the soft switch was set to 1, a direct connection is made to the facsimile. If a facsimile. If it was set to 0 accidentally, receive ring is set to 1. If it was above 9, receive rings are set to 9. So, this has to be corrected.

- SW1 to SW13: For line 1
- SW14 to SW26: For line 2

SW3 No. 5 ~ No. 8 Switch to auto-receive from manual receive (0: No switch)

Choice is made after how many rings in the manual receive mode it should be automatically change to auto answer mode or remain in the manual receive mode. Entering the binary number 0 forces the machine to remain in the manual answer mode. If a number between 1 and 9 is entered, the machine will go into the answer mode after the given number of rings. However, it can be used as an ordinary telephone if the handset is taken off the hook before this programmed number is finished. If entry of a number above 9 by accident, it will be set to 9. In this case, it must be corrected to the proper number.

SW4 No. 1 ~ No. 3 Communication results printout

It is possible to obtain communication results after each transaction. Normally, the switch is set (No. 1: 0, No. 2: 0, No. 3: 1) so that the communication result is produced only a communication error is encountered. If No. 1 was set to 1, No. 2 was set to 1 and No. 3 was set to 0, the communication result will be produced every time a communication is done, even if the communication was successful.

If No. 1 was set to 0, No. 2 to 1 and No. 3 to 0, the communication result will be produced every transmission.

Setting No. 1 to 1 No. 2 to 0 and No. 3 to 0 will disable this function. No transaction report will be printed.

If No. 1 was set to 0, No. 2 to 0 and No. 3 to 0, the communication result is produced only after a timer and memory transmission or when a communication error is encountered.

SW4 No. 4 Image addition function to the communication result table (for memory transmission only)

Used to set addition of sending image to the communication result table.

SW4 No. 5 Reserved

Set to "0".

SW4 No. 6 TEL billing code function

When set to "1", the TEL billing code function is enabled.

SW4 No. 7 Billing code position

When set to "1", the billing code is delivered before dialing the remote number. When set to "0", the billing code is delivered after dialing.

SW4 No. 8 Multi-TTI feature

When this switch is set to "1", Multi TTI function is enabled.

SW5 No. 1 Time display format

When this switch is set to "0", time is displayed in 12-hour system.

When set to "1", 24-hour system.

SW5 No. 2 Date display format

Used to select date display/print formats.

SW5 No. 3 Header print

When it is set at 0, sender's name, sending page number and so on are automatically printed in the recording paper on the receiving side during transmission. Thus, the sender can be known on the receiving side.

0: Applied.

1: Not applied.

SW5 No. 4 Footer print

When set to "1", the date of reception, the sender machine No., and the page No. are automatically recorded at the end of reception.

SW5 No. 5 Relay data output

0: Output ON

1: Output OFF

SW5 No. 6 Substitute reception

Selection of substitute reception in the case of recording paper exhausted or paper jam. If set to "NO", auto receive is disabled even when the receive memory is ready to receive.

Substitute reception is not performed even during receive operation.

SW5 No. 7 Substitute reception condition

Selection of substitute reception according to existence of TEL number from transmitting side. Initial setting allows substitute reception without CSI. If set to "no", the receiver cannot receive any documents.

SW5 No. 8 CSI transmission

CSI signal contains the sender's phone number registered in the machine. If this switch is set to "1", no sender's name will be printed at the receiving side.

SW6 No. 1 MH fixed

Normally set to allow automatic selection of MH and MR mode according to the remote side.

If set to 1, the mode is fixed to MH and is useful if the remote side is a MH only unit; or a lot of image distortion is met due to a bad line.

SW6 No. 2 H2 mode

Used to determine H2 mode (15 sec transmission mode). When set to OFF, H2 mode is inhibited even though the transmitting machine has H2 mode.

SW6 No. 3, No. 4 Reserved

Set to "0".

SW6 No. 5 ~ No. 8 Modem speed (DCS date reception speed)

Used to determine the initial modem speed. The default is 14400BPS (V17). It may be necessary to program it to a slower speed when frequent line fallback is encountered, in order to save the time required for the fallback procedure.

SW7 No. 1, No. 2 Reception speed fixed

The transferable speed of modem in the receiving mode is set.

SW7 No. 3 DIS receive acknowledge during G3 transmission

Used to make a choice of whether reception of NSF (DIS) is acknowledged after receiving two NSFs (DISs) or receiving one NSF (two DISs).

It may be useful for overseas communication to avoid an echo suppression problem, if set to 1.

SW7 No. 4 Non-modulated carrier in V29 transmission mode

Though transmission of a non-modulated carrier is not required for transmission by the V29 modem according to the CCITT Recommendation, it may be permitted to send a non-modulated carrier before the image signal to avoid an echo suppression problem.

It may be useful for overseas communication to avoid an echo suppression problem, if set to 1.

SW7 No. 5 EOL detection timer

Used to make a choice of whether to use the 25-second or 13-second timer for detection of End of line.

This is effective to override communication failures with some facsimile models that have longer End of line detection.

SW7 No. 6 Protocol Monitor

Normally set to "0". If set to "1", communication can be checked, in case of troubles, without using a G3 tester or other tools.

When communication FSK data transmission or reception is made, the data is taken into buffer. When communication is finished, the data analyzed and print out. When data is received with the line monitor (SW7-No. 7) set to "1" the reception level is also print out.

SW7 No. 7 Line monitor

Normally set to "0". If set to "1", the transmission speed and the reception level are displayed on the LCD. Used for line tests.

SW7 No. 8 Max. length for TX/RX/Copy

Used to set the maximum page length.

To avoid possible paper jam, the page length is normally limited to 432 mm for copy or transmit, and 1.5 meters for receive.

It is possible to set it to "No limit" to transmit/receive a long document, such as a computer print form, etc. (In this case, the receiver/transmitter must also be set to no limit.)

SW8 No. 1, No. 2 Compromised Equalizer

The specific line equalizer is inserted.

No. 1	No. 2	
0	0	The line equalizer built in the modem is turned off.
0	1	Line equalizer corresponding to 1.8 km
1	0	Line equalizer corresponding to 3.6 km
0	1	Line equalizer corresponding to 7.2 km

SW8 No. 3 Reserved

Set to "0".

SW8 No. 4 Pause time

This relates to the pause code of dial signal. When this switch is set to "1", the 1st pause is 2 seconds, and the 2nd and subsequent pauses are 1 second. In case of "0", the 1st pause is 4 seconds, and the 2nd and subsequent pauses are 2 seconds.

SW8 No. 5 ~ No. 8 Signal transmission level

Used to control the signal transmission level in the range of -0dB to -15dB.

SW9 No. 1 CED tone signal interval

For international communication, the 2100Hz CED tone may act as an echo suppresser switch, causing a communication problem. Though this soft switch is normally set to "0", it should be set to "1" so as to change the time between CED tone and DIS signal from 75ms to 500ms to eliminate the communication problem caused by echo.

SW9 No. 2 CI signal OFF detect enable time

Used to set the continuous detection time during OFF period of CI signal. Normally set to 700ms, where the short ring (500ms: OFF period) cannot be detected. Therefore, selection of 350ms is allowed.

SW9 No. 3 Equalization freeze

This switch is used to perform reception operation by fixing the equalizer control of modem for the line which is always in unfavorable state and picture cannot be received. Usually, the control is executed according to the state of line where the equalizer setting is changed always.

SW9 No. 4 Equalization freeze conditions

Setting which specifies SW9 No.3 control only in condition of 7200bps modem speed.

SW9 No. 5 Reserved

Set to "0".

SW9 No. 6 CED detection time.

The detection time of the CED signal from the called side in the auto calling mode is set.

SW9 No. 7, No. 8 Reserved

Set to "0".

SW10 No. 1 ~ No. 4 Reserved

Set to "0".

SW10 No. 5 ~ No. 8 Distinctive ringing

When the ringing setting is turned off, all of the CI signal is received. When any of the standard, and ring patterns 1 through 3 is selected for the ringing setting, only the selected CI signal is received.

CI signal patterns.

The CI signal patterns consists of the standard pattern, and ring patterns 1 through 7. The standard pattern is the conventional one.

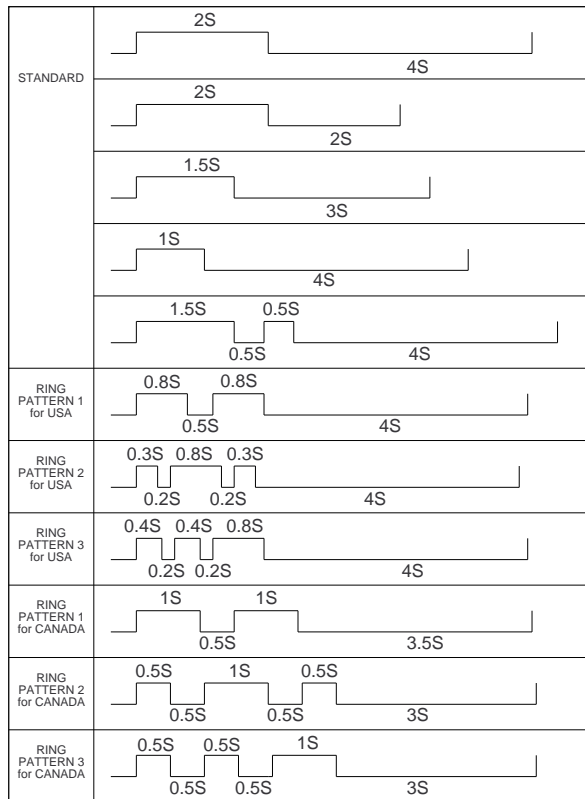
**SW11 No. 1 ~ No. 4 Memory retransmission times**

The number of memory retransmissions is set.

SW11 No. 5 ~ No. 8 Memory retransmission interval

The interval between memory retransmissions is set.

SW12 No. 1, No. 2 Reserved

Set to "0".

SW12 No. 3, No. 4 Alarm buzzer

The length of the buzzer for normal end of operation is set.

SW12 No. 5 Action when RTN received

The operation is set when the RTN signal is received in the G3 transmission mode.

SW12 No. 6 V.34 mode function in case of manual communication

Used to select whether the V.34 mode is made valid when automatically transmitting/receiving.

SW12 No. 7 V.34 mode function

Used to select the V.34 mode for communication when set to "1", communication method is V.34 mode.

SW12 No. 8 V.34 control channel communication speed

Used to select the control channel communication speed for V.34 mode.

SW13 No. 1 ~ No. 4 V.34 mode transmission speed

Used to determine the initial modem speed when communication method is V.34 transmission mode.

SW13 No. 5 ~ No. 8 V.34 mode receiving speed

Used to determine the initial modem speed when communication method is V.34 reception mode.

SW14 No. 1 Reserved

Set to "0".

SW14 No. 2 Reserved

Set to "1".

SW14 No. 3 Reserved

Set to "0".

SW14 No. 4 Reserved

Set to "1".

SW14 No. 5, No. 6 Reserved

Set to "0".

SW14 No. 7 Reserved

Set to "1".

SW14 No. 8 Reserved

Set to "0".

SW15 No. 1 Dialing mode

Switch the type according to the telephone circuit connected to the facsimile.

0: PULSE DIAL

1: TONE DIAL

SW15 No. 2 Reserved

Set to "1".

SW15 No. 3, No. 4 Reserved

Set to "0".

SW15 No. 5, No. 6 Reserved

Set to "1".

SW15 No. 7, No. 8 Reserved

Set to "0".

SW16 No. 1 ~ No. 4 Number of rings for auto-receive (0: No ring receive)

When the machine is set in the auto receive mode, the number of rings before answering can be selected. It may be set from one to nine rings using a binary number. If the soft switch was set to 1, a direct connection is made to the facsimile. If a facsimile. If it was set to 0 accidentally, receive ring is set to 1. If it was above 9, receive rings are set to 9. So, this has to be corrected.

SW16 No. 5 ~ No. 8 Reserved

Set to "0".

SW17 No. 1, No. 2 Reserved

Set to "0".

SW17 No. 3, No. 4 Reserved

Set to "1".

SW17 No. 5, No. 6 Reserved

Set to "0".

SW17 No. 7 Reserved

Set to "1".

SW17 No. 8 Reserved

Set to "0".

SW18 No. 1 Reserved

Set to "0".

SW18 No. 2 Reserved

Set to "1".

SW18 No. 3 ~ No. 8 Reserved

Set to "0".

SW19 No. 1 ~ No. 4 Reserved

Set to "0".

SW19 No. 5 ~ No. 8 Modem speed (DCS date reception speed)

Used to determine the initial modem speed. The default is 14400BPS (V17). It may be necessary to program it to a slower speed when frequent line fallback is encountered, in order to save the time required for the fallback procedure.

SW20 No. 1, No. 2 Reception speed fixed

The speed of modem in the receiving mode is set.

SW20 No. 3 DIS receive acknowledge during G3 transmission

Used to make a choice of whether reception of NSF (DIS) is acknowledged after receiving two NSFs (DISs) or receiving one NSF (two DISs). It may be useful for overseas communication to avoid an echo suppression problem, if set to 1.

SW20 No. 4 Non-modulated carrier in V29 transmission mode

Though transmission of a non-modulated carrier is not required for transmission by the V29 modem according to the CCITT Recommendation, it may be permitted to send a non-modulated carrier before the image signal to avoid an echo suppression problem.

It may be useful for overseas communication to avoid an echo suppression problem, if set to 1.

SW20 No. 5 EOL detection timer

Used to make a choice of whether to use the 25-second or 13-second timer for detection of End of line.

This is effective to override communication failures with some facsimile models that have longer End of line detection.

SW20 No. 6 Protocol Monitor

Normally set to "0". If set to "1", communication can be checked, in case of troubles, without using a G3 tester or other tools.

When communication FSK data transmission or reception is made, the data is taken into buffer. When communication is finished, the data analyzed and print out. When data is received with the line monitor (SW7-No. 7) set to "1" the reception level is also print out.

SW20 No. 7 Line monitor

Normally set to "0". If set to "1", the transmission speed and the reception level are displayed on the LCD. Used for line tests.

SW20 No. 8 Reserved

Set to "0".

SW21 No. 1, No. 2 Compromised Equalizer

The specific line equalizer is inserted.

No. 1 No. 2

0 0 The line equalizer built in the modem is turned off.

0 1 Line equalizer corresponding to 1.8 km

1 0 Line equalizer corresponding to 3.6 km

0 1 Line equalizer corresponding to 7.2 km

SW21 No. 3 Reserved

Set to "0".

SW21 No. 4 Pause time

This relates to the pause of dial signal. When this switch is set to "1", the 1st pause is 2 seconds, and the 2nd and subsequent pauses are 1 second. In case of "0", the 1st pause is 4 seconds, and the 2nd and subsequent pauses are 2 seconds.

SW21 No. 5 ~ No. 8 Signal transmission level

Used to control the signal transmission level in the range of -0dB to -15dB.

SW22 No. 1 CED tone signal interval

For international communication, the 2100Hz CED tone may act as an echo suppresser switch, causing a communication problem. Though this soft switch is normally set to "0", it should be set to "1" so as to change the time between CED tone and DIS signal from 75ms to 500ms to eliminate the communication problem caused by echo.

SW22 No. 2 CI signal OFF detect enable time

Used to set the continuous detection time during OFF period of CI signal. Normally set to 700ms, where the short ring (500ms: OFF period) cannot be detected. Therefore, selection of 350ms is allowed.

SW22 No. 3 Equalization freeze

This switch is used to perform reception operation by fixing the equalizer control of modem for the line which is always in unfavorable state and picture cannot be received. Usually, the control is executed according to the state of line where the equalizer setting is changed always.

SW22 No. 4 Equalization freeze conditions

Setting which specifies SW9 No.3 control only in condition of 7200bps modem speed.

SW22 No. 5 Reserved

Set to "0".

SW22 No. 6 CED detection time.

The detection time of the CED signal from the called side in the auto calling mode is set.

SW22 No. 7, No. 8 Reserved

Set to "0".

SW23 No. 1 ~ No. 4 Reserved

Set to "0".

SW23 No. 5 ~ No. 8 Distinctive ringing

When the ringing setting is turned off, all of the CI signal is received.
When any of the standard, and ring patterns 1 through 3 is selected for the ringing setting, only the selected CI signal is received.

CI signal patterns

The CI signal patterns consists of the standard pattern, and ring patterns 1 through 7. The standard pattern is the conventional one.

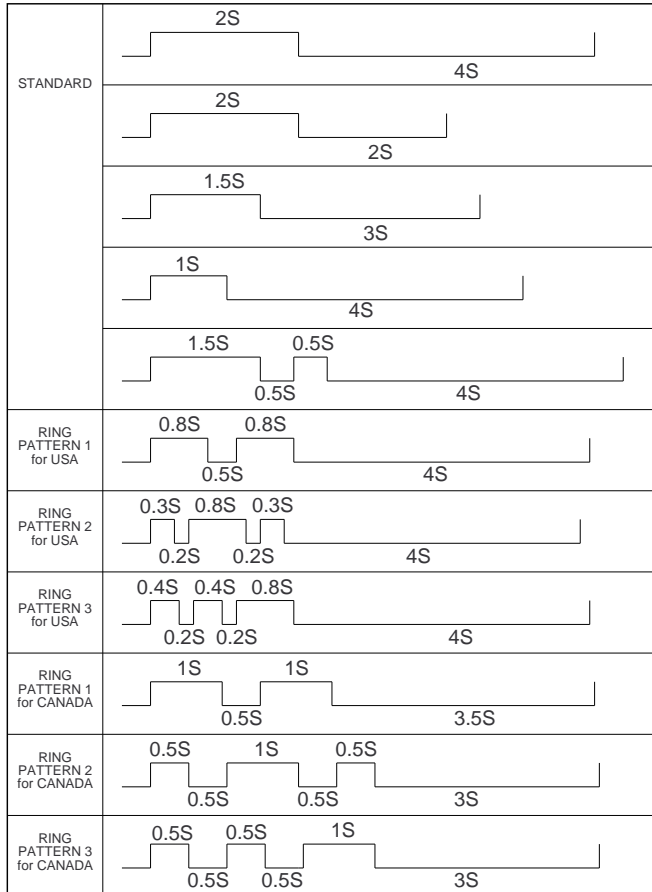
**SW24 No. 1 Reserved**

Set to "1".

SW24 No. 2 Reserved

Set to "0".

SW24 No. 3 Reserved

Set to "1".

SW24 No. 4 ~ No. 8 Reserved

Set to "0".

SW25 No. 1~ No. 5 Reserved

Set to "0".

SW25 No. 6 Reserved

Set to "1".

SW25 No. 7 V.34 mode function

Used to select the V.34 mode for communication when set to "1", communication method is V.34 mode.

SW25 No. 8 V.34 control channel communication speed

Used to select the control channel communication speed for V.34 mode.

SW26 No. 1 ~ No. 4 V.34 mode transmission speed

Used to determine the initial modem speed when communication method is V.34 transmission mode.

SW26 No. 5 ~ No. 8 V.34 mode receiving speed

Used to determine the initial modem speed when communication method is V.34 reception mode.

SW27 No. 1 ~ No. 3 Line condition setting

The communication conditions of lines 1/2 are set respectively.

SW27 No. 4 Preference line specification

In the case when it is allowed to select the line 1 or 2 in the transmission mode, the preference line is set.

SW27 No. 5, No. 6 Key buzzer volume

Key buzzer volume:

The sound volume of key inputting buzzer and other buzzers is set.

SW27 No. 7, No. 8 Reserved

Set to "0".

SW28 No. 1, No. 2 Speaker volume

Speaker volume:

The sound volume of the speaker in the on-hook mode is set.

SW28 No. 3, No. 4 Handset volume

Handset volume:

The volume of sound heard from the receiver is set.

SW28 No. 5, No. 6 Ringer volume

Ringer volume:

The calling sound volume of CI signal receiving is set.

SW28 No. 7, No. 8 Reserved

Set to "0".

SW29 No. 1 Line to be used in PC I/F mode

The line to communicate in the PC I/F mode is set.

SW29 No. 2 PC I/F mode

PC I/F mode:

The interface with the personal computer is selected.

SW29 No. 3 Auto receive with PC I/F

Automatic receiving of I/F mode:

Which receives the call is determined.

SW29 No. 4 ~ No. 8 Reserved

Set to "0".

SW30 No. 1, No. 2 Reserved

Set to "0".

SW30 No. 3 Continuous serial polling

Turns on/off the continuous polling function.

SW30 No. 4, No. 5 Dialing interval in continuous serial polling

Used to set continuous serial polling interval time.

SW30 No. 6, No. 7 Reserved

Set to "0".

SW30 No. 8 Quick on-line

It is selected whether auto dial call is activated in the memory input mode when one document is completely read or when all pages are completely read.

SW31 No. 1 ~ No. 4 Reserved

Set to "0".

SW31 No. 5 Reserved

Set to "1".

SW31 No. 6 Reserved

Set to "0".

SW31 No. 7 Reserved

Set to "1".

SW31 No. 8 Reserved

Set to "0".

SW32 No. 1 Print hold

When set to "1", the print hold function is enabled.

**SW32 No. 2 Document transmission in Super G3 mode
(Refer to Page 2-44.)**

When this switch is set to "1", even if documents are sent, the communication in the super G3 mode is possible. In case of "0", document transmission is made at a rate of 14.4 kbps or below (V.17/V.33/V.29/V.27ter).

SW32 No. 3 Reserved

Set to "0".

SW32 No. 4 Changeover of Print cassette

When the cassette selection priority is set to the upper priority or the lower priority and paper in the cassette is exhausted, this function is used to set changeover of the cassette of not.

SW32 No. 5 ~ No. 8 Selection of print cassette

Used to set the priority of selection of the recording paper cassettes. (Auto selection/Upper priority/Lower priority)

SW33 No.1 No. 2 Heater mode

Used to set ON/OFF of the heater. Three settings are available: always ON, always OFF, and OFF timer. (Only when Off timer is selected, SW34-SW37 settings are valid.)

SW33 No. 3 ~ No. 5 Density adjustment of print bias

The density of printing is set.

It can be also set in the print diagnosis mode.

SW33 No. 6, No. 7 Drum life limit

The drum life-over judgment conditions are set.

SW33 No. 8 Reserved

Set to "0".

SW34 No. 1 ~ No. 4 Start time of heater OFF time (Upper digit of hour)

Used to set the start time of the heater OFF timer. (Enter in 24-hour system.)

SW34 No. 5 ~ No. 8 Start time of heater OFF time (Lower digit of hour)

Used to set the start time of the heater OFF timer. (Enter in 24-hour system.)

SW35 No. 1 ~ NO. 4 Start time of heater OFF time (Upper digit of minute)

Used to set the start time of the heater OFF timer. (Enter in 24-hour system.)

SW35 No. 5 ~ No. 8 Start time of heater OFF time (Lower digit of hour)

Used to set the start time of the heater OFF timer. (Enter in 24-hour system.)

SW36 No. 1 ~ No. 4 End time of heater OFF time (Upper digit of hour)

Used to set the end time of the heater OFF timer. (Enter in 24-hour system.)

SW36 No. 5 ~ No. 8 End time of heater OFF time (Lower digit of hour)

Used to set the end time of the heater OFF timer. (Enter in 24-hour system.)

SW37 No. 1 ~ No. 4 End time of heater OFF time (Upper digit of minute)

Used to set the end time of the heater OFF timer. (Enter in 24-hour system.)

SW37 No. 5 ~ No. 8 End time of heater OFF time (Lower digit of minute)

Used to set the end time of the heater OFF timer. (Enter in 24-hour system.)

SW38 No. 1 Reserved

Set to "1".

SW38 No. 2 ~ No. 8 Reserved

Set to "0".

SW39 No. 1 Reserved

Set to "0".

SW39 No. 2 Reserved

Set to "1".

SW39 No. 3 ~ No. 8 Reserved

Set to "0".

SW40 No. 1 Reserved

Set to "1".

SW40 No. 2 ~ No. 8 Reserved

Set to "0".

SW41 No. 1, No. 2 Reserved

Set to "0".

SW41 No. 3 Reserved

Set to "1".

SW41 No. 4, No. 5 Reserved

Set to "0".

SW41 No. 6 Reserved

Set to "1".

SW41 No. 7 Reserved

Set to "0".

SW41 No. 8 Reserved

Set to "1".

SW42 No.1, No. 2 Reserved

Set to "0".

SW42 No. 3 Reserved

Set to "1".

SW42 No. 4, No. 5 Reserved

Set to "0".

SW42 No. 6 Reserved

Set to "1".

SW42 No. 7 Reserved

Set to "0".

SW42 No. 8 Reserved

Set to "1".

SW43 No. 1 Reserved

Set to "1".

SW43 No. 2 ~ No. 5 Reserved

Set to "0".

SW43 No. 6 Reserved

Set to "1".

SW43 No. 7 Reserved

Set to "0".

SW43 No. 8 Reserved

Set to "1".

SW44 No. 1 Automatic printing of activity report

This soft switch is used to select; whether or not to produce the activity report when the memory is full (about 50 items). An activity report can be produced when the following key entry command is made.

"FUNC", "2", "#", "START"

After producing the activity report, all the data in the memory will be cleared.

When the switch function is set to "0" (NO), the data in memory will be deleted from the oldest as it reaches the maximum memory capacity (approx. 50 items).

SW44 No. 2 Printout of total time and total number of pages on activity report

Used to make a choice of whether the total communication time and pages are recorded in the activity report.

SW44 No. 3 Reserved

Set to "0".

SW44 No. 4 Department function

This model has the department audit feature, it has to be set to 1 to utilize this feature.

SW44 No. 5 ~ No. 8 Department ID digit

Used to set the department ID digit number. When set to "D", the number is "4".

SW45 No. 1 Picture qualitypriority mode

Used to set the transmission mode which is automatically selected when the MODE key is not pressed. In the copy mode, however, the fine mode is automatically selected unless the MODE key is manually set to another mode.

SW45 No. 2 Cut-off mode (when copy mode)

When in copy, if the scanned data is out of the range of recording, the operator has one of the choices below using the switch.

0: Continue: Data is printed onto the next page with the last 20mm also printed at the beginning of the next page.

1: Cut off: Data scanned out of the limit is cut off (a page is printed.)

SW45 No. 3 Scanning ratio in memory input

In the case of memory transmission, etc., only letter size (A4) documents can be stored in the memory. To input B4 documents into the memory, therefore, the B4 documents must be reduced to letter size (A4) or the both ends of the B4 documents will be cut off to input the center letter-size (A4) portion. This switch provides the selection.

0: Reduced to A4 size and inputted.

1: The both ends are cut off and the center portion (A4 size) is inputted.

SW45 No. 4 Verification STAMP

End stamp:

It is set whether the red round mark is stamped at the bottom margin of the document of every page in the memory input mode and document sending mode or not.

SW45 No. 5 Overseas communication mode selection function (Refer to Page 2-44.)

When this switch is set to "1", the communication in Super G3 mode can be turned off by pressing the "SPACE" key before sending operation, for the transmission set after that (including polling).

SW45 No. 6 ~ No. 8 Reduce ratio (when copy mode)

Reduction ratio of copying is set.

It can be changed even in the optional mode.

SW46 No. 1, No. 2 Reserved

Set to "0".

SW46 No. 3, No. 4 Density adjustment (when Fine/STD mode)

This is used for density adjustment in fine/standard mode. Adjust the density according to that of frequently used original.

Set to "Dark" for darker reading (either in the auto or the dark mode) of light original. Set to "Light" for lighter reading (either in the auto or the dark mode) of dark original.

Set to "Dark only in dark mode" for darker reading only in the dark mode.

SW46 No. 5, No. 6 Density adjustment (when Half-tone mode)

This is used for density adjustment in the half tone. Setting procedures are the same as SW46 No. 3, No. 4.

SW46 No. 7 HTF correction in Half-tone mode

In the half tone mode, image area is separated from character area and processed separately to eliminate unclear character transmission. This switch is used to change the criteria of judgement of separation. When "Strong" (= 1) is selected, more area is judged as character area, providing clearer characters.

On the contrary, however, edges of image area may be emphasized.

It is advisable to restrict the use of this function only when clear characters must be transmitted, and to use the function of "Weak" (= 0) for general cases.

SW46 No.8 MTF correction in Half-tone mode

This allows selection of MTF correction (dimness correction) in the half tone mode. When "NO" (= 1) is selected, the whole image becomes soft and mild, On the contrary, however, clearness of characters will be reduced. Normally set to "NO" (= 1).

SW47 ~ SW55 No. 1 ~ No. 8 Reserved

Set to "0".

SW56 No. 1 ~ No. 4 Reserved

Set to "1".

SW56 No. 5 Printing when toner empty

It is set whether printing is stopped for empty toner or not.

SW56 No. 6 ~ No. 8 Reduction of print data

Reduction ratio of receiving is set.

It can be changed even in the optional mode.

SW57 ~ SW68 No. 1 ~ No. 8 Reserved

Set to "0".

SW69 No. 1 (Cassette define (LTR/A4): Tray

A4 cassette can be used.

Set 0 or 1 for all of three bits.

Do not change the setting during printing.

SW69 No. 2 Cassette define (LTR/A4): Upper

A4 cassette can be used.

Set 0 or 1 for all of three bits.

Do not change the setting during printing.

SW69 No. 3 Cassette define (LTR/A4): Lower

A4 cassette can be used.

Set 0 or 1 for all of three bits.

Do not change the setting during printing.

SW69 No. 4 Separation of image area in the half-tone

This allows selection of MTF correction (dimness correction) in the half tone mode. When "NO" (= 1) is selected, the whole image becomes soft and mild, On the contrary, however, clearness of characters will be reduced. Normally set to "NO" (= 1).

SW69 No. 5 Removal of notch in the binary mode

The notch signal is removed in the binary mode.

SW69 No. 6, No. 7 Reserved

Set to "1".

SW69 No. 8 Reserved

Set to "0".

SW70 No. 1 ~ No. 4 Reserved

Set to "1".

SW70 No. 5 ~ No. 8 Reserved

Set to "0".

**SW71 No. 1 ~ No. 4 Black line detection
(When transmission scanning).**

Number of continuous judgements of black lines during duplex scan.

**SW71 No. 5 ~ No. 8 All white page detection
(When transmission scanning)**

Ratio of black and white during duplex scan.

SW72 No. 1 ~ No. 4 Black line detection (When copy scanning)

Number of continuous judgements of black lines during duplex scan.

SW72 No. 5 ~ No. 8 White page detect (When copy scanning)

Ratio of black and white during duplex scan.

SW73 No. 1 Reserved

Set to "1".

SW73 No. 2 ~ No. 7 Reserved

Set to "0".

SW73 No. 8 Reserved

Set to "1".

SW74 No. 1 Reserved

Set to "0".

SW74 No. 2, No. 3 Reserved

Set to "1".

SW74 No. 4 ~ No. 8 Reserved

Set to "0".

SW75 No. 1 Reserved

Set to "0".

SW75 No. 2 Reserved

Set to "1".

SW75 No. 3 ~ No. 8 Reserved

Set to "0".

SW76 No. 1 ~ No. 5 Reserved

Set to "1".

SW76 No. 6 ~ No. 8 Reserved

Set to "0".

SW77 No. 1 ~ No. 8 Reserved

Set to "0".

SW78 No. 1 Secure billing code

When the Tel. Billing Code function is ON, the operation of SECURE BILLING CODE is enabled.

SW78 No. 2 Pause with Z key

The pause corresponding to the Z key is inserted for Secure Billing Code input.

SW78 No. 3 Reserved

Set to "0".

SW78 No. 4 ~ No. 8 Z key pause time (250 ms unit)

The Z key pause time is set

SW79 No. 1 ~ No. 4 Reserved

Set to "1".

SW79 No. 5 ~ No. 8 Reserved

Set to "0".

SW80 No. 1, No. 2 Reserved

Set to "0".

SW80 No. 3, No. 4 Reserved

Set to "1".

SW80 No. 5 Reserved

Set to "0".

SW80 No. 6, No. 7 Reserved

Set to "1".

SW80 No. 8 Reserved

Set to "0".

SW81 No. 1 ~ No. 4 Reserved

Set to "0".

SW81 No. 5 Reserved

Set to "1".

SW81 No. 6 ~ No. 8 Reserved

Set to "0".

SW82 No. 1 Reserved

Set to "1".

SW82 No. 2, No. 3 Reserved

Set to "0".

SW82 No. 4 Reserved

Set to "1".

SW82 No. 5, No. 6 Reserved

Set to "0".

SW82 No. 7, No. 8 Reserved

Set to "1".

SW83 No. 1 Reserved

Set to "0".

SW83 No. 2 Reserved

Set to "1".

SW83 No. 3 ~ No. 5 Reserved

Set to "0".

SW83 No. 6, No. 7 Reserved

Set to "1".

SW83 No. 8 Reserved

Set to "0".

SW84 No. 1, No. 2 Reserved

Set to "0".

SW84 No. 3 Reserved

Set to "1".

SW84 No. 4 ~ No. 7 Reserved

Set to "0".

SW84 No. 8 Reserved

Set to "1".

SW85 No. 1, No. 2 Reserved

Set to "0".

SW85 No. 3 Reserved

Set to "1".

SW85 No. 4 ~ No. 7 Reserved

Set to "0".

SW85 No. 8 Reserved

Set to "1".

SW86 No. 1 F.A.S.T (Remote maintenance system) mode

Used to determine remote maintenance system (F.A.S.T) function.

SW86 No. 2 F.A.S.T. (Remote maintenance system) line

The line where the F.A.S.T. function is set.

SW86 No. 3 Day light saving feature

The Day light saving function ON/OFF is set.

SW86 No. 4 Separate mode

The Separate mode ON/OFF is set.

SW86 No. 5, No. 6 Reserved

Set to "0".

SW86 No. 7 CNG send when manual TX

CN G signal sending ON/OFF in case of manual transmission is set

SW86 No. 8 Ringer of line 2

The ringer ringing ON/OFF is set when incoming call is received through the line 2.

SW87 No. 1 Reserved

Set to "0".

SW87 No. 2, No. 3 Addition of header to various lists

ON/OFF of addition of header (sender information) to various lists is set.

SW87 No. 4, No. 5 Relay instruction transmission line specification

The line to be used for relay specification transmission is set.

In case of AUTO setting the line specified in the transmission operation is used.

SW87 No. 6 Reserved

Set to "1".

SW87 No. 7, No. 8 Reserved

Set to "0".

SW88 No. 1 Reserved

Set to "0".

SW88 No. 2 Reserved

Set to "1".

SW88 No. 3 ~ No. 8 Reserved

Set to "0".

SW89 ~ SW96 No. 1 ~ No. 8 Reserved

Set to "0".

SW97 No. 1 ~ No. 4 Reserved

Set to "0".

SW97 No. 5 ~ No. 8 Reserved

Set to "1".

SW98 No. 1 ~ No. 8 Reserved

Set to "0".

SW99 No. 1 ~ No. 8 Reserved

Set to "0".

[3] Troubleshooting

1. Fax troubleshooting

Refer to the following actions to troubleshoot any of problems mentioned in 1-4.

- [1] A communication error evoked.
- [2] Image distortion produced.
- [3] Unable to do overseas communication.
- [4] Communication speed slow liable to fallback.
 - Increase the transmission level SOFT SWITCH 8-5, 6, 7, 8 Can be used in case [1] [2] [3]
 - Decrease the transmission level SOFT SWITCH 8-5, 6, 7, 8 Can be used in case [3]

- Apply line equalization SOFT SWITCH 8-1, 2
Can be used in all cases.
- Slow down the transmission speed SOFT SWITCH 6-4, 5, 6, 7, 8
Can be used in case [2] [3]
- Replace the TEL/LIU PWB.
Can be used in all cases.
- Replace the control PWB.
Can be used in all cases.

* If transmission problems still exist on the machine, use the following format and check the related matters.

TO: _____ ATT: _____ Ref.No.: _____
 CC: _____ ATT: _____ Date: _____
 FM: _____ Dept: _____
 _____ Sign: _____

***** Facsimile communication problem *****		Ref.No.: _____																					
From: Mr. _____ Fax Tel No.: _____		Date: _____																					
Our customer	Name _____	Tel No. _____																					
	Address _____	Fax No. _____																					
	Contact person _____	Model name _____																					
Other party	Name _____	Tel No. _____																					
	Address _____	Fax No. _____																					
	Contact person _____	Model name _____																					
Problem mode	Line: Domestic / international _____	Mode: G3 _____																					
	Reception / Transmission _____	Phase: A. B. C. D. _____																					
	Automatic reception / Manual reception _____ Automatic dialing / Manual dialing / Others _____																						
Frequency: _____ %		ROM version: _____																					
Confirmation item			Please mark problem with an X																				
			No problem is: 0																				
			<table border="1" style="width: 100%; text-align: center;"> <tr> <td>A1</td><td>A2</td><td>B1</td><td>B2</td><td>C1</td><td>C2</td><td>D1</td><td>D2</td><td>E1</td><td>E2</td> </tr> <tr> <td> </td><td> </td><td> </td><td> </td><td> </td><td> </td><td> </td><td> </td><td> </td><td> </td> </tr> </table>	A1	A2	B1	B2	C1	C2	D1	D2	E1	E2										
	A1	A2	B1	B2	C1	C2	D1	D2	E1	E2													
		Transmission level setting is () dB at our customer																					
		Transmission level () dBm																					
		Reception level () dBm																					
		By level meter at B1 and B2																					
Comment																							
Countermeasure																							
**** Please attach the G3 data and activity report on problem. ****																							

2. Printer trouble detection

(1) Paper jam

The printer recognizes if paper remains inside the printer by detecting the status of the Paper Take-Up Sensor (PC1) and the Paper Exit Sensor (PC3). A paper jam is detected by the timing that PC1 and PC3 become activated or deactivated.

When a paper jam is detected, the drive for all elements is stopped except for the Fan Motor (M3), excluding the two following cases.

- During multi printing

When condition 1 listed below is detected and paper remains in the printer, all elements except the Fan Motor (M3) will be stopped after the paper is fed out of the printer.

- During single printing

When condition 1 listed below is detected and paper does not remain in the printer, elements except the Heater Lamp (H1) and Fan Motor (M3) will be stopped.

1. The Paper Take-Up Sensor (PC1) does not activate within 2 sec, after the Paper Take-Up Roller in the printer starts rotating, or within 4 sec. after the Paper Take-Up Roller in the optional 250 Sheet Second Tray starts rotating.
2. The Paper Take-Up Sensor (PC1) activates when the Power ON/OFF Switch (S1) is turned ON, or when the Upper Unit is closed.
3. The Paper Exit Sensor (PC3) activates when the Power ON/OFF Switch(S1) is turned ON, or when the Upper Unit is closed.
4. The Paper Take-Up Sensor (PC1) does not deactivate within 11 sec. after the paper leading edge reaches the Paper Take-Up Sensor (PC1).
5. The Paper Exit Sensor (PC3) does not activate within 3.5 to 4.5 sec. after the paper leading edge reaches the Paper Take-Up Sensor (PC1).
6. The Paper Exit Sensor (PC3) does not deactivate within 3.4 to 4.7 sec. after the paper trailing edge passes the PaperTake-Up Sensor (PC1).

(2) Laser malfunction

All elements except the Exit Fan Motor (M3) are deactivated when the malfunctions described below are detected.

The LDVR1 signal or LDVT2 signal deviates from the specified value while the laser power is adjusted.

LDVR1/LDVR2 : These signals are to adjust the laser drive current.

(3) Polygon motor malfunction

1. The SSCAN signal has not been entered once within 1 sec. after the Polygon Motor is energized.
2. The number of Polygon Motor rotations has not stabilized within \pm 4.2 sec. after the Motor is energized.
3. The number of Polygon Motor rotations has exceeded \pm 3% for more than 0.5 sec. after the Motor is energized and the rotation number stabilizes within \pm 0.5%.

(4) Fusing malfunction

1. The temperature detected by the Thermistor has not risen 20°C for 50 msec. within 12 to 30 sec. after the warming up. (This detection applies only when the Thermistor detecting temperature is 90°C or less.)
2. The Thermistor detecting temperature has not reached to 172°C within 60 sec. after warming up.
3. Except in the Pause Mode*, the Thermistor detecting temperature during the idle state has fallen to 80°C or lower for 50 msec., or the temperature during printing has fallen to 133°C or lower.
4. The Thermistor detecting temperature has exceeded 193°C for 50 msec. during temperature control.

*Pause Mode : During this mode, the control temperature is decreased to save power during the idle state, the Heater Lamp being turned OFF.

(5) Exit fan malfunction

The voltage equivalent to the current*1 of the Exit Fan Motor remains 160 mV or lower for 2 sec.

*1: detected by converting the Motor current into voltage.

How to Reset these malfunctions

Turn OFF The Power ON/OFF Switch (S1).

3. Printer troubleshooting

1. PAPER JAM

(1) Paper jam occurred when the Power ON/OFF Switch (S1) is turned ON, or when the Upper Unit is closed.

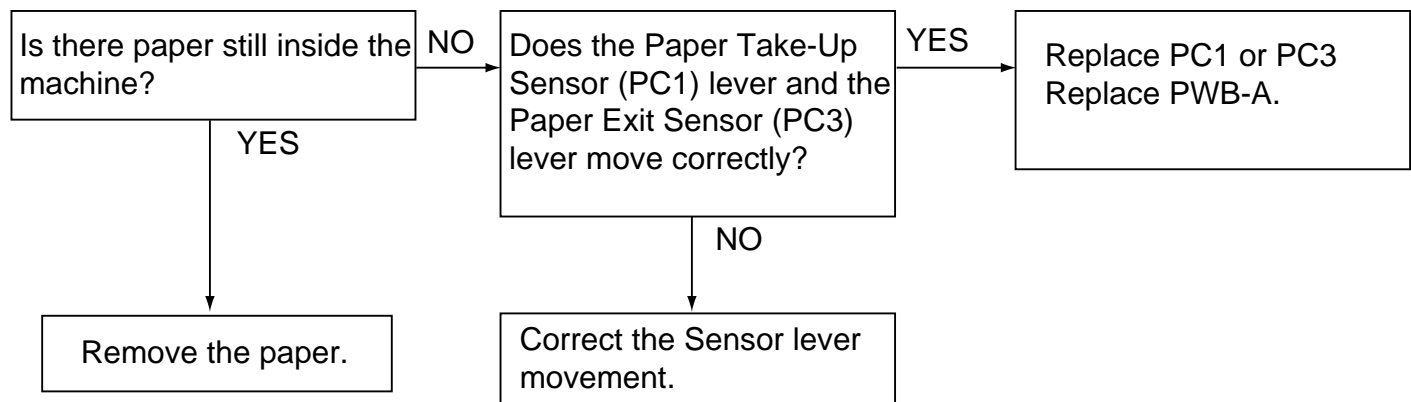

(2) Paper jam occurred at the paper take-up section

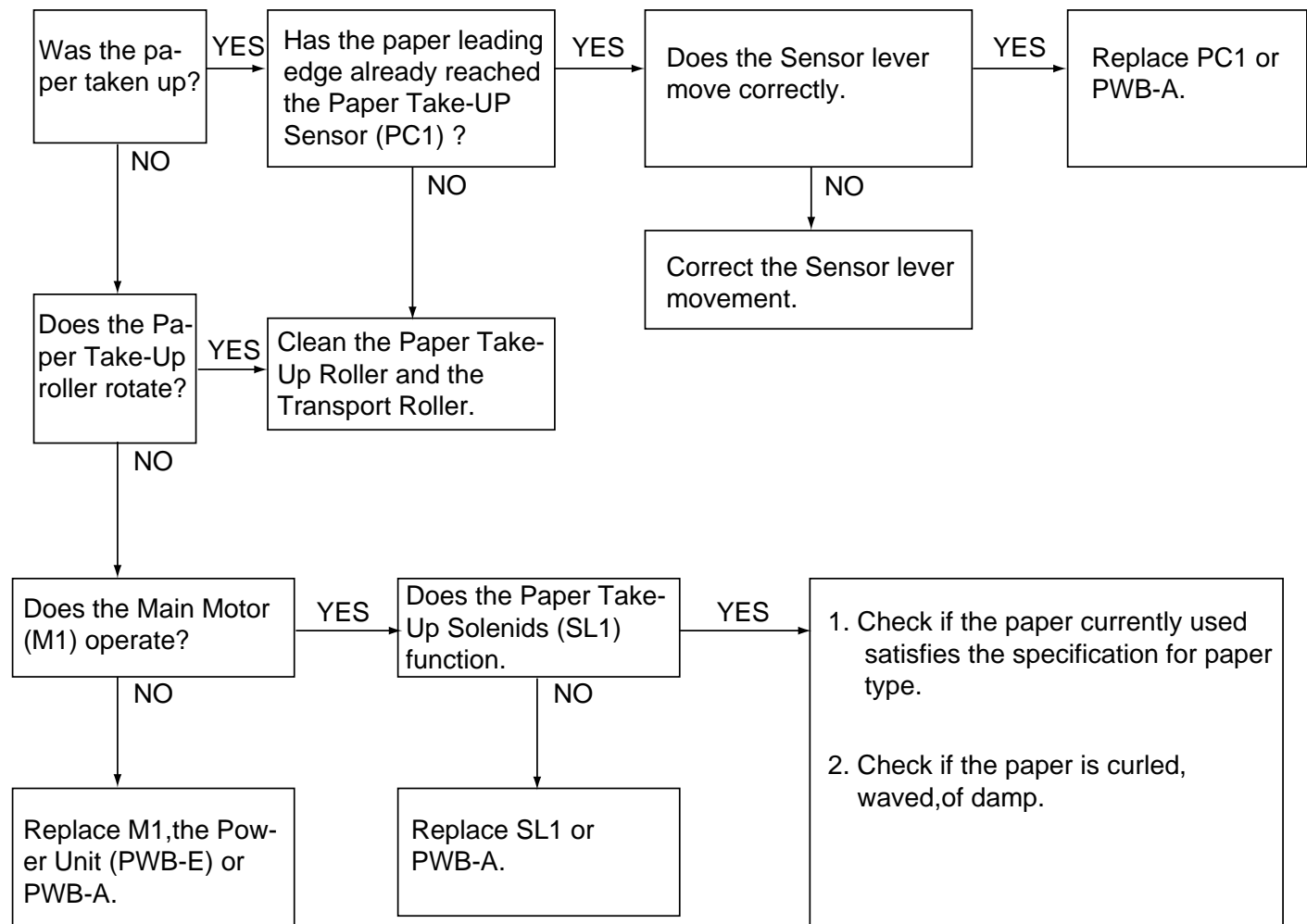

(3) Paper jam occurred at the paper transport section

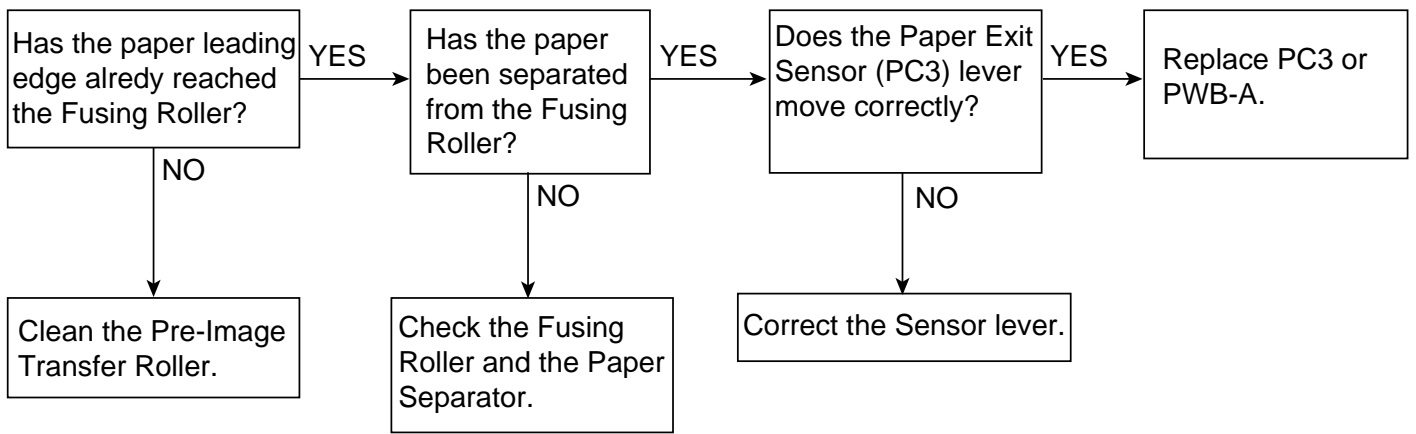

2. UNIT ERROR

(1) Laser malfunction

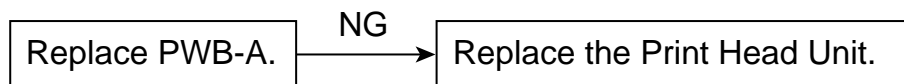

(2) Polygon motor malfunction

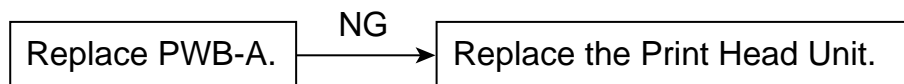

(3) Fusing malfunction

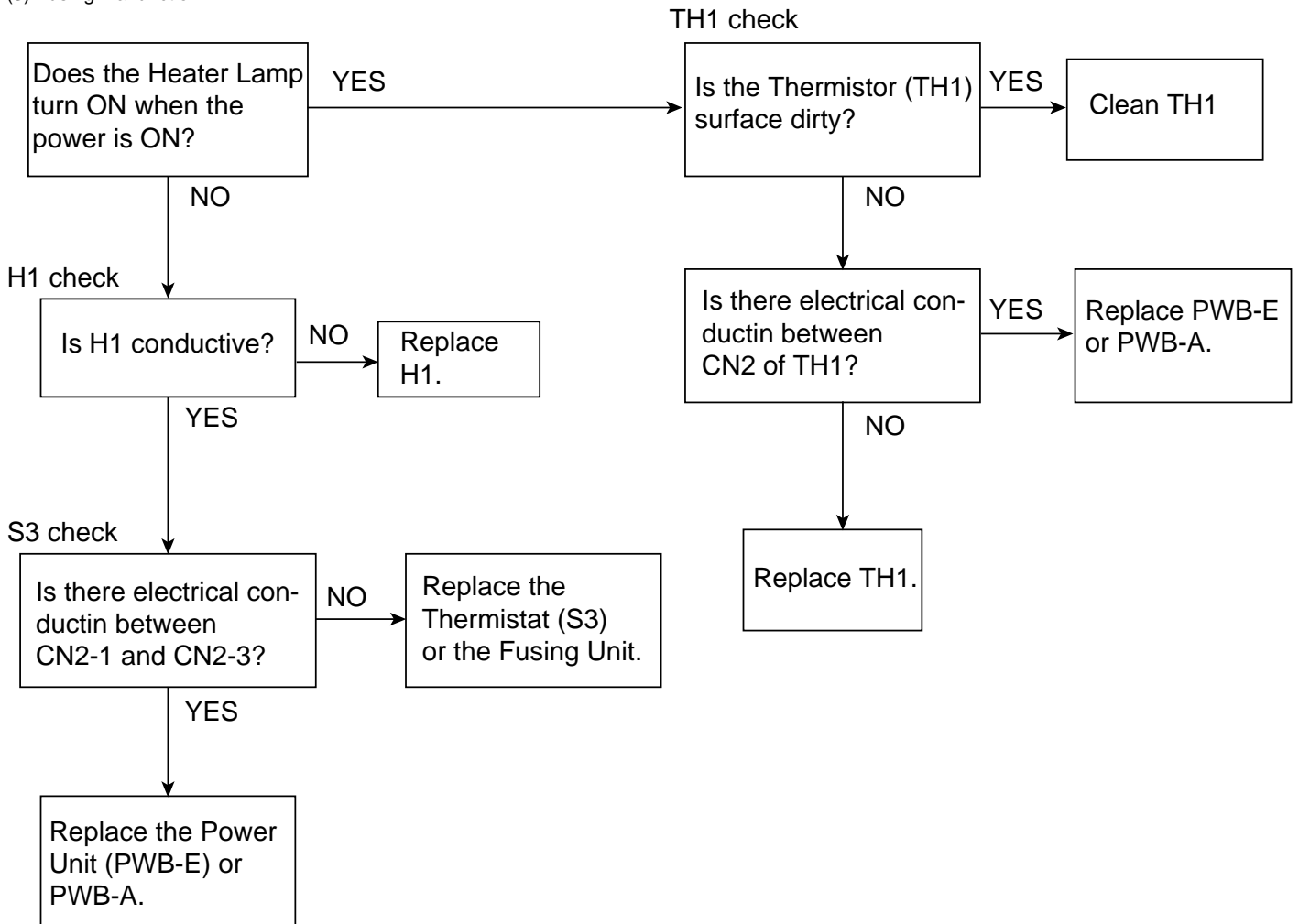

(4) Exit fan malfunction

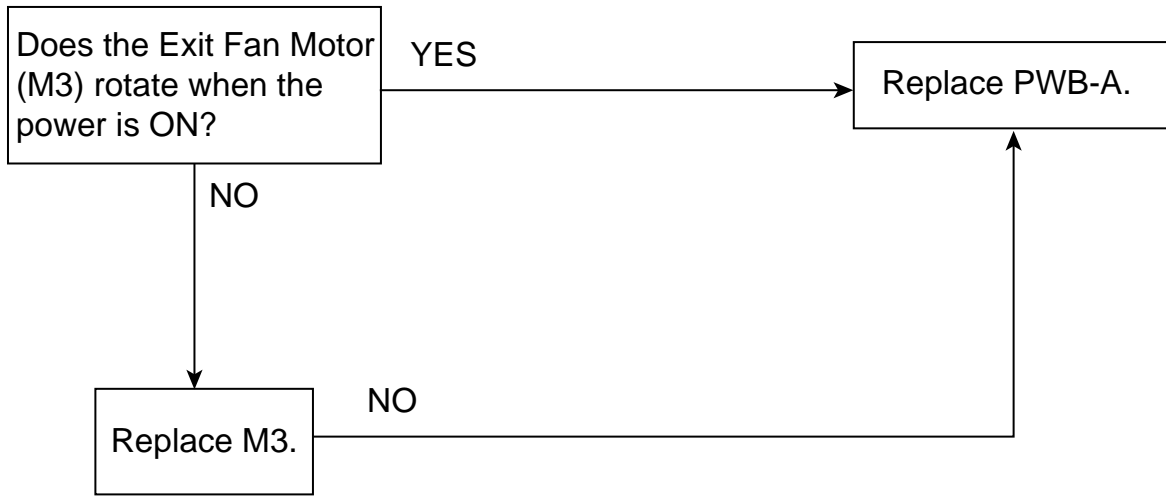

3. OTHER TROUBLE SHOOTING

(1) No Power

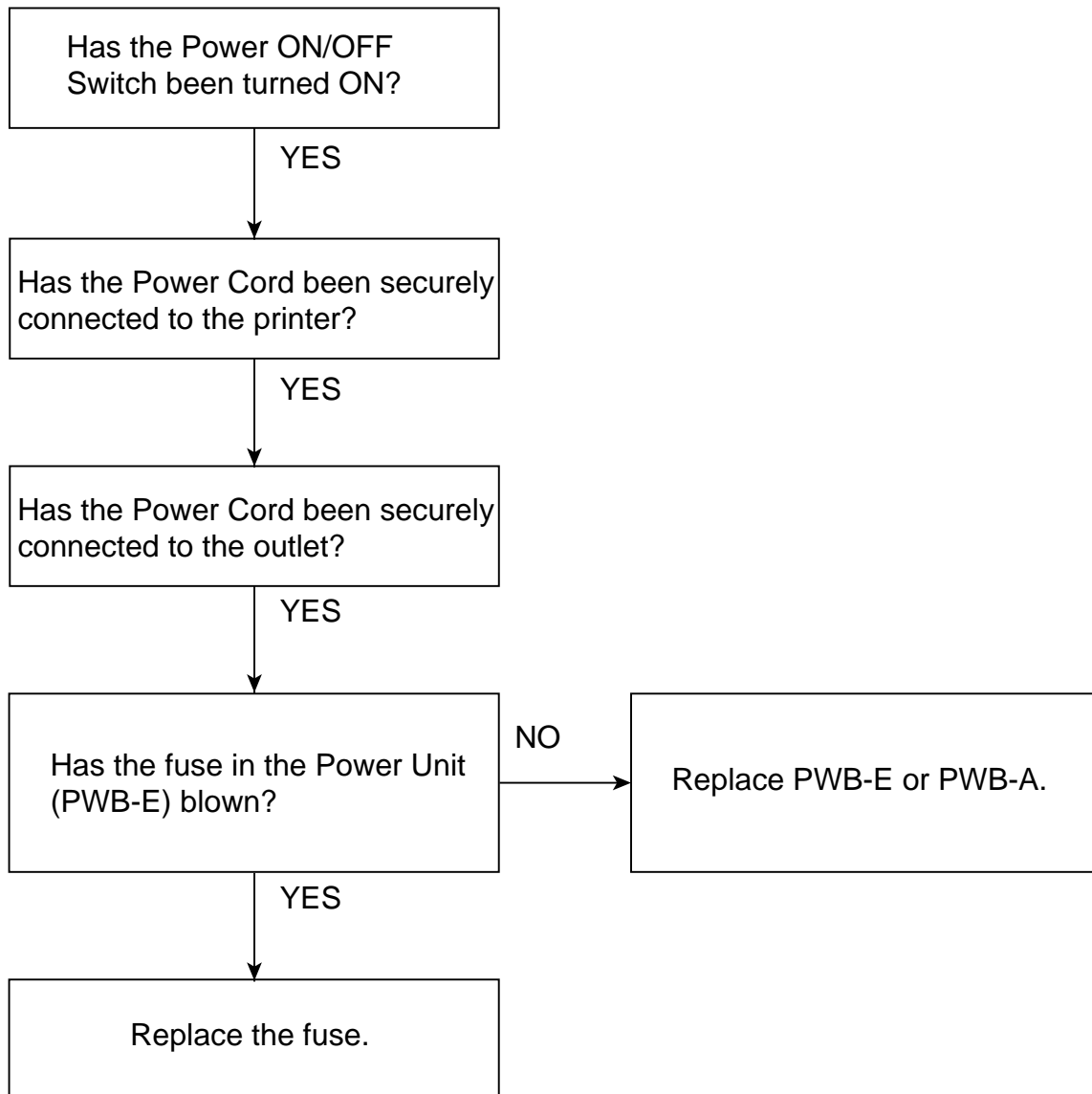

[4] ERROR CODE TABLE

1. Communication error code table

G3 Transmission

Code	Final received signal	Error Condition (Receiver side)
0	Incomplete signal frame	Cannot recognize bit stream after flag
1	NSF, DIS	Cannot recognize DCS signal by echo etc. Cannot recognize NSS signal (FIF code etc)
2	CFR	Disconnects line during reception (carrier missing etc)
3	FTT	Disconnects line by fall back
4	MCF	Disconnects line during reception of multi page Cannot recognize NSS, DCS signal in the case of mode change
5	PIP or PIN	The line is hung up without replying to telephone request from the receiving party.
6	RTN or RTP	Cannot recognize NSS, DCS signal after transmit RTN or RTP signal.
7	No signal or DCN	No response in receiver side or DCN signal received* (transmitter side)
8	–	Owing to error in some page the error could not be corrected although the specified number of error retransmission was attempted.
11	–	Error occurred after or while reception by the remote (receiving) machine was revealed to be impossible.
12	–	Error occurred just after fallback.
13	–	Error occurred after a response to retransmission end command was received.

G3 Reception

Code	Final received signal	Error Condition (Receiver side)
0	Incomplete signal frame	Cannot recognize bit stream after flag
1	NSS, DCS	Cannot recognize CFR or FTT signal Disconnects line during transmission (line error)
2	NSC, DTC	Cannot recognize NSS signal (FIF code etc)
3	EOP	Cannot recognize MCF, PIP, PIN, RTN, RTP signal
4	EOM	Cannot recognize MCF, PIP, PIN, RTN, RTP signal in the case of mode change
5	MPS	The line is hung up without replying to communication request.
6	PR1-Q	Cannot recognize PIP, PIN signal in the case of TALK request
7	No signal or DCN	No response in transmitter (cannot recognize DIS signal) or DCN signal received* (receiver side)
8	–	Error occurred upon completion of reception of all pages.
9	–	Error occurred when mode was changed or Transmission/Reception switching was performed.
10	–	Error occurred during partial page or physical page reception.
11	–	Error occurred after or during inquiry from the remote (transmitting) machine as to whether reception is possible or not.
12	–	Error occurred during or just after fallback.
13	–	Error occurred after the retransmission end command was received.

Super G3 Mode

Error Code	Transmission Errors	Reception Errors
E-16	Same as E-0	Same as E-0
E-17	Same as E-1	Same as E-1
E-18	Same as E-2	Same as E-2
E-19	–	Same as E-8
E-20	Same as E-4	Same as E-9
E-21	–	Same as E-10
E-22	–	–
E-23	Same as E-7	Same as E-7
E-24	Same as E-8	–
E-25	Same as E-11	Same as E-11
E-26	Same as E-12	Same as E-12
E-27	Same as E-13	Same as E-13
E-28	–	Same as E-14
E-29	Error occurred during handshaking for super G3 mode	
E-30		
E-31		

<Reference> Details of E-29~31

E-29	Handshaking error in V.8 negotiation procedure
E-30	Handshaking error in V.34 line probing procedure
E-31	Handshaking error in V.34 HDX training procedure

2. Service call error message

1. HEATER ERROR
2. LASER ERROR
3. POLYGON ERROR
4. FAN ERROR
5. PCU COMM, ERROR

[5] OVERSEAS COMMUNICATION MODE**(1) Function**

The Super G3(V.34) mode is susceptible to influence of line. It is better to use the G3(V.17) mode for communication in specific line conditions. This function is provided to support this status.

(2) Memory retransmission

In case of memory transmission the retransmission is performed in the following conditions.

No.	Conditions	Operation
1	When a communication error occurred in communication in the Super G3 mode due to page 1 MCF reception failure.	The retransmission of this communication is performed after setting Super G3 to OFF (in V.17 mode).
2	When a communication error occurred in communication in the Super G3 mode after reception of page 1 MCF.	The retransmission of this communication is performed without setting Super G3 to OFF (in V.34 mode).
3	When a communication error occurred in retransmission.	Retransmission is performed again according to 1 and 2 above.
4	When a communication error occurred in sequential system communication.	Retransmission is performed according to 1 and 2 above for each station.

(3) Original transmission

Since retransmission is not provided for the original transmission, recovery by the method 1 is impossible. Accordingly, for the original transmission set Super G3 to OFF (default), and apply V.17 mode.

This function can be set to ON or OFF by using the soft switch.

SW32 No.2 = 0: Super G3 off (default) = 1: Super G3 on

This setting has priority over the Super G3 function setting to OFF by operator which is discussed in item (4).

(4) Super G3 function setting to OFF by operator

A function to set Super G3 function to OFF is provided for operator in addition to the functions described in items (2) and (3) above. However, this function is invalid in the default mode.

It is made valid only when requested by using the soft switch.

SW27 No.4 = 0: Operation invalid (Default) 1: Operation valid

(4)-1 Setting method

- ① Before communication operation press the SPACE key to set the communication to OFF in the Super G3 mode.

- ② Perform the transmission/polling operation.

The operations which are taken as objects are the following.

- * Instantaneous single station auto-dial transmission (original/memory)
- * Time-specified single station transmission
- * Program instantaneous single station transmission
- * Program time-specified single station transmission
- * Time-specified single station polling
- * Program instantaneous single station polling
- * Program time-specified single station polling
- * Manual transmission (original/memory)
- * Batch transmission

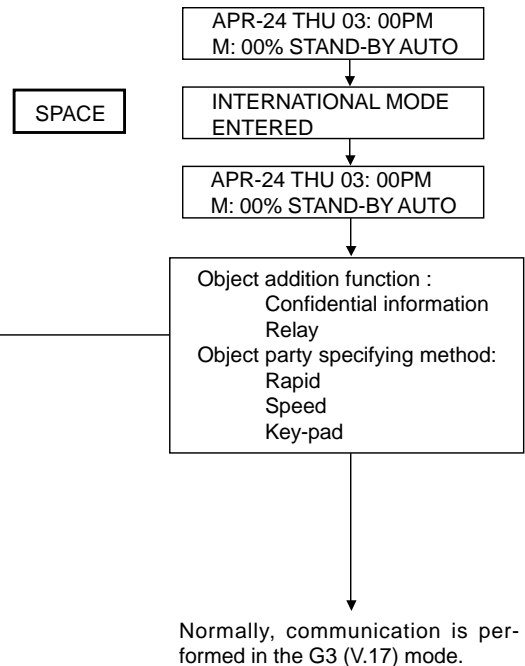

(4)-2 Canceling method (this setting is not canceled while one of the following operations is not performed)

- ① After setting operation (pressing the SPACE key) press the STOP key on the WAIT screen.

- ② After setting operation (pressing the SPACE key) hold for one minute.

In case of operation ① and ② the display shown right will appear for 2 seconds.

- ③ Perform the communication operation (all the communication operations).

- ④ Start up again the machine (turn on power).

(4)-3 Others

- ① The operation to set Super G3 to OFF is valid only for one communication which is performed successively.

INTERNATIONAL MODE
CANCELED